

OPEN CONDUCTOR SYSTEMS



Open Conductor System

Content	Page
General.....	3
Selection of conductors	6
Technical Data	7
Steel-Copperhead conductors L20	9
Accessories L20.....	10
Steel-Copperhead conductors F35	11
Accessories F35	12
Steel-Copperhead conductors F45.....	13
Accessories F45	14
Aluminium-Copperhead conductors A20	16
Accessories A20	17
Aluminium-Copperhead conductors A35	18
Accessories A35	19

Content	Page
Aluminium-Copperhead conductors A45	20
Accessories A45	21
Solid copper conductors C	23
Solid copper conductor accessories	24
Insulators with rail holder	27
Insulators without rail holder	28
Rail holder	30
Rail supports	31
Selection of current collector	32
Current collectors	33
Spare parts for current collectors	37
Grounding and short circuiting equipment.....	40
De-icing systems	41
Questionnaire	44

General

VAHLE copperhead conductors were invented in 1912 by engineer Paul Vahle. The T-profile, with their attached copperhead, replaced conventional bare copper wires, which encountered frequent contact difficulties, considerable spark formation and wire breaks. Attaching a copper profile to a T-shaped steel foot achieved a level of mechanical stability which provided safe contact between conductor and current collector.

This results in a higher service life of the system, wear to the copper conductor is hardly detectable.

As a result of continual development, our conductors and components have a current capacity which meets our customers' requirements at the most demanding conditions.

Our main customers are all businesses that use lifting gear, particularly smelters, foundries and steel mills, transshipment and dockyard companies, shipyards, coking installations, the cement industry, etc.

Aluminium-Copperhead conductors

with copper heads are especially efficient due to their low weight and high conductivity.

Solid copper conductors

are recommended for high current requirement and for use in wet environment.

Conductors are available for capacities up to 2360 A. Please contact us when higher capacities are required. Expansion joints are available to compensate for conductor expansion or contraction due to temperature changes.

If desired, conductors can be bent according to the customer's drawings. De-icing systems are available for all conductors. In-ground conductor trench systems as well as above ground crash proof steel duct and elevated safety duct systems as per catalog 10b can be equipped with copperhead conductors.

IEC 60 204–32 (2009 excerpt)

This standard applies for the use of electric and electronic equipment and systems for hoisting gear and corresponding equipment.

Conductor lines and slinging bodies

Protection against direct contact

Conductor lines and slinging bodies must be installed or enclosed to ensure that protection is provided against direct contact during usual access to the lifting gear, e.g. over the track platform or crane carrier platform by one of the following protective measures:

- Protection by partially insulating the active parts. This is the preferred measure.
- Protection by enclosing or covering with a protection category of at least IPXXB or IP2X (see IEC 60364–4–41, Section A.2).

Upper horizontal surface of covers or enclosures that are easy to access must have a minimum protection category of IPXXD or IP4X.

In cases where the protection category is not fulfilled the following additional measures must be applied:

- a) protection through clearance between active parts (see IEC 60364–4–41; Section B.3) in conjunction with EMERGENCY STOP complying with 9.2.5.4.3 or, where this is not feasible;
- b) protection by maintaining the dimensions in images 1a, 1b or 1c (derived from ISO 13852).

This measure is intended for application in areas where only specialist or instructed personnel have access and where special conditions exist (e.g., hot areas of rolling mills or in chemical companies).

Note:

Examples of obstacles via unprotected conductor lines are protective conductors and wire mesh.

Conductor lines must be arranged and / or protected so that

- contact, especially from unprotected conductor lines with conductive parts, such as switch operating cords, strain relief equipment and (drive) control chains, is prevented.
- damage from swinging loads is prevented.

In cases where the protection category is effective for the conductor line (e.g., in the area of the current collector), additional equipment must be provided (e.g. additional obstacles).

In the event that current circuits have to be routed for different crane isolated sections via conductor lines or slinging bodies, each of these current circuits must be protected against direct contact by a protection category of at least IP2X or IPXXB (see IEC 60529).

1 a)

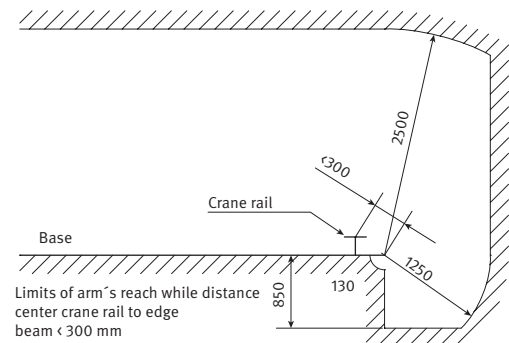

1 b)

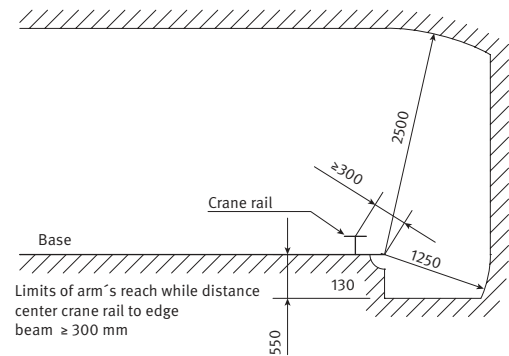

1 c)

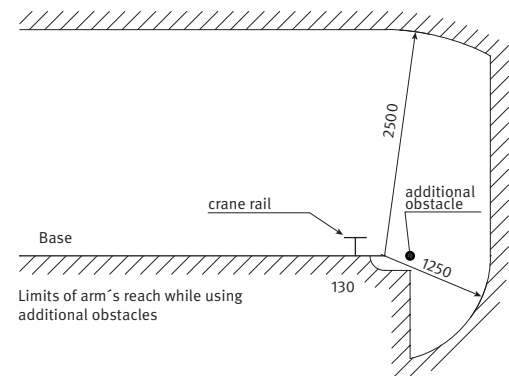

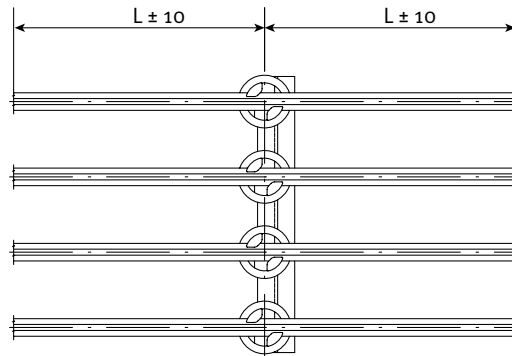
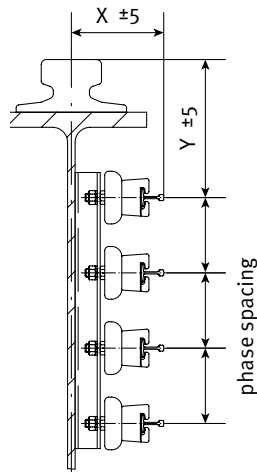

Insulator and support distance

Conductors L 20, A 20, C 20 (Dimension L): distance max. 2.0 m
 all other conductors (Dimension L): distance max. 2.5 m
 The support brackets are attached to the crane track or respective structures. Phase distance (holes in the support brackets): 150 mm with low voltage, 350 mm with medium voltage up to 10 kV.
 In confined space conditions, the phase distance of conductors L 20, A 20 and C 20 must be no less than 100 mm and no less than 120 mm for all other conductor types.

The support brackets must be aligned during assembly so that the conductors run parallel to the runway or track of the device. A sufficient air gap between the conductor(s) and ground must be ensured. The insulators are mounted on steel brackets and are attached either directly or using adjustable threaded bolts. The height of the conductors can be adjusted within a certain limit using shorter insulator threaded bolts. Differences between the phases and grounding conductors can also be compensated using shorter bolts.

In order to achieve an equal working height for the conductors, it is absolutely essential to make sure that the conductor surfaces are at the same level. The insulators must be mounted on the bracket in such a manner that the holder will not prevent the conductor from sliding while expanding/contracting. After tightening, check the insulators again so there is sufficient play. Equal wear is required in order to increase the service life of the carbon brush. To achieve this, a zig-zag arrangement of the conductors is required. The zig-zag arrangement is achieved by the respective positioning of the holes (slotted holes in the steel brackets, or by attaching offset (welding)). The reference dimension is the crane runway. The size of the amplitude for routing the conductors depends on the width of the carbon brushes.

Connector

Conductors are connected using rigid joints or expansion joints. We recommend that you clean all contact surfaces and apply a thin coat of contact grease. Expansion joints are not required for a system length of up to 100 m. Expansion joints are installed at high temperature fluctuations and a system length of more than 100 m (this can be determined separately for each system). An insulator must be mounted 250 mm from the expansion joint.

Locating clamps

In order to achieve controlled expansion of the conductor, fixpoints must be created. For this purpose, two locating clamps are placed to either side of the insulator. Fixpoints are always centered between two expansion joints.

Feeder clamps

Feeder clamps are mounted at the intended feed points. The contact surfaces must be clean and a thin coat of contact grease applied.

Please note:

When working in galvanizing plants or pickling shops, with aggressive environmental conditions, or using low voltages, we request that you submit a more detailed query, especially with regard to environmental conditions. In order to process quotations and orders, we require drawings if the conductors are to be delivered with curves or section isolation, or if it is intended for branch terminal lines, turntables or switches.

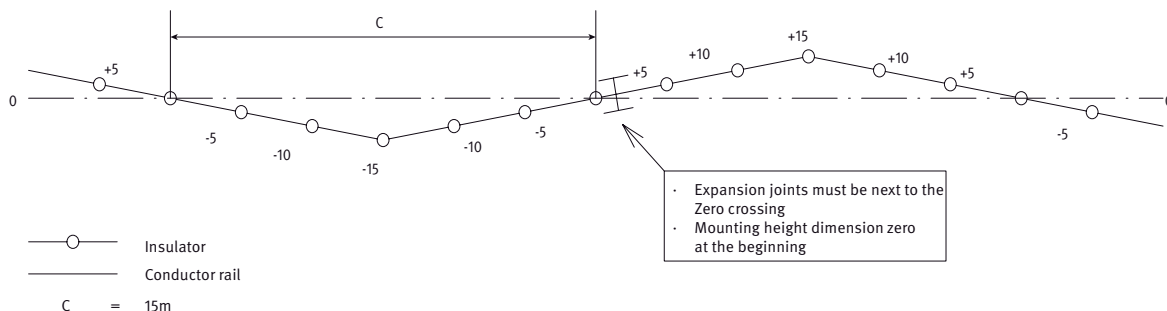

Selection of conductors

In order to simplify the selection of the conductors and current collectors, depending on ambient conditions, there is a table for selecting conductors on this page and a table for selecting current collectors on page 32.

In addition to the electrical layout, the tables will assist in choosing the correct conductor quickly.

These tables limit the different conductors in their respective areas of application and provide an overall overview of their application depending on the ambient temperature.

In steel mills with a high degree of particle contamination, note F 45/100 or min. C 45 with ceramic insulators and expansion joint distance of max. 42 m have to be used.

Chemical influences

Type	Indoor / Outdoor systems without particular environmental conditions	Indoor / Outdoor systems with corrosive conditions	Indoor / Outdoor systems with intensive corrosive conditions	Indoor / Outdoor systems with aggressive environmental conditions (pickling shops, zinc coating installations)
Steel-copperhead conductors	•	• ⁽¹⁾	• ⁽¹⁾	• ⁽²⁾
Aluminium-copperhead conductors	•	•	–	–
Solid copper conductor	•	•	•	•

Operating temperature

Type	Operating temperature
Steel-copperhead conductors	-40 °C - +200 °C
Aluminium-copperhead conductors	-40 °C - +150 °C
Solid copper conductors	-40 °C - +200 °C

• = suitable
– = not suitable

⁽¹⁾ = Surface protection required
⁽²⁾ = Special coating

Technical Data

Type	Resistance Ohm/1000 m at AT= 20 °C	Impedance ⁽²⁾ Ohm/1000 m at AT= 20 °C	equivalent copper cross- section mm ²	Load capacity at 60% duty ⁽¹⁾ A	Load capacity at 80% duty ⁽¹⁾ A	Load capacity at 100% duty ⁽¹⁾ A
L 20 / 14	0.496	0.540	36	285	245	220
L 20 / 25	0.380	0.434	47	335	290	260
L 20 / 50	0.248	0.322	72	425	370	330
L 20 / 100	0.146	0.245	122	580	505	450
F 35 / 30	0.259	0.333	69	415	360	320
F 35 / 50	0.201	0.287	89	530	460	410
F 35 / 100	0.128	0.236	139	685	595	530
F 35 / 150	0.094	0.215	189	825	715	640
F 35 / 200	0.075	0.202	239	940	815	730
F 45 / 50	0.175	0.260	102	645	560	500
F 45 / 100	0.117	0.221	152	800	695	620
F 45 / 150	0.088	0.203	202	940	815	730
F 45 / 200	0.071	0.192	252	1070	930	830
F 45 / 300	0.051	0.179	352	1290	1120	1000
F 45 / 400	0.040	0.172	452	1500	1300	1160
F 45 / 500	0.032	0.165	552	1680	1455	1300
F 45 / 600	0.027	0.162	652	1860	1610	1440
A 20 / 14	0.198	0.288	90	580	505	450
A 35 / 30	0.112	0.231	160	775	670	600
A 35 / 50	0.099	0.222	180	880	760	680
A 35 / 100	0.078	0.208	230	1035	895	800
A 45 / 50	0.079	0.203	225	1020	885	790
A 45 / 100	0.065	0.193	275	1190	1030	920
A 45 / 150	0.055	0.187	325	1330	1150	1030
A 45 / 200	0.048	0.181	375	1435	1240	1110
A 45 / 300	0.038	0.172	475	1680	1455	1300
A 45 / 400	0.031	0.167	575	1870	1620	1450
C 20 / 200	0.089	0.218	200	930	805	720
C 35 / 400	0.045	0.138	400	1395	1210	1080
C 45 / 500	0.036	0.175	500	1560	1355	1210
C 45 / 600	0.030	0.171	600	1770	1530	1370
C 45 / 800	0.022	0.165	800	2040	1765	1580
C 60 / 1000	0.018	0.158	1000	2580	2240	2000
C 60 / 1200	0.015	0.152	1200	3050	2640	2360

(1) Continuous current details at AT = 35 °C

(2) Impedance of conductors at 150 mm distance between phases and 50 Hz

Checking voltage drop for start-up current

The position of the feed point can initially be determined according to on-site circumstances, usually at the end of the system (end power feed).

If nothing else is specified, a guideline value for the max. voltage drop in the conductor of 3% of the nominal voltage can be assumed.

If this value is exceeded, the voltage drop can be reduced by changing the power feed length (l) or by arranging additional feeds. If necessary, the next larger conductor may even have to be selected.

Power feed lengths (l):

– With end feeder clamp: $l = L$

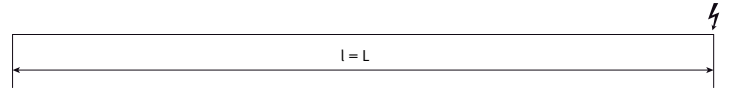

– With middle feeder clamp: $l = \frac{L}{2}$

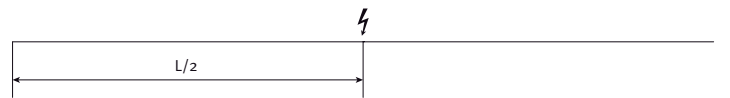

– With feeder clamps at both ends: $l = \frac{L}{4}$



– With 2 feeder clamps: (favorable arrangement) $l = \frac{L}{6}$

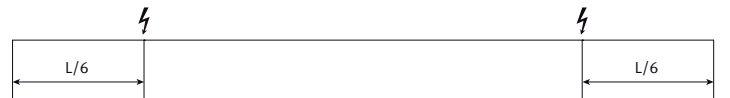

– With 3 feeder clamps: $l = \frac{L}{10}$

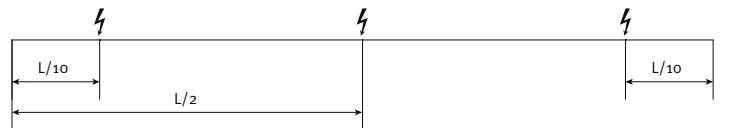

– With 4 feeder clamps: $l = \frac{L}{14}$

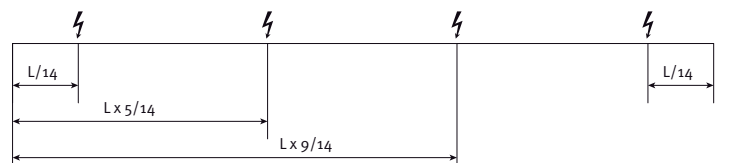

– With 5 feeder clamps: $l = \frac{L}{18}$

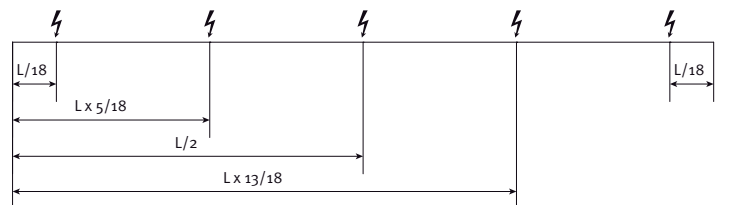

Steel-Copperhead conductors L20

Reference code:

L = Steel T-profile, light version
 20 = T-profile foot width b in mm
 14 = Copper cross-section (mm²)

Bending at the factory:

Minimum bending radius: R min. = 600 mm
 max. support distance: 600 mm

Bending over the foot, head and lip is possible

Bending over the copperhead is not possible with L 20/14

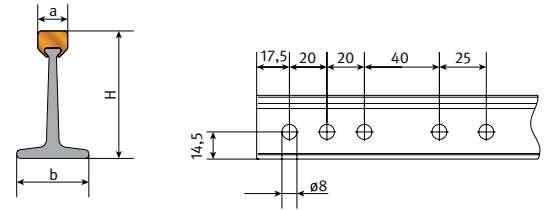

- Standard length: 7 m
 - Short sections: on request
 - Support distance: 2 m in straight runs
 - Suitable current collectors: DVD, GSV1
- The steel profile can be supplied hot galvanized or coated.

Type	Cross section Copperhead mm ²	Cross section Steel mm ²	Equivalent Total copper cross-section mm ²	H mm	a mm	b mm	Weight kg/m	Order no. ⁽¹⁾
L 20 / 14	14	150	36	31.0	6.5	20.0	1.24	100 00•
L 20 / 25	25	150	47	33.0	8.0	20.0	1.34	100 01•
L 20 / 50	50	150	72	34.0	10.0	20.0	1.57	100 02•
L 20 / 100	100	150	122	38.5	12.0	20.0	2.02	100 03•

(1) The last figure of the Ident. no. states the individual length in meters. Please add 1, 2,...7 to the order no. Intermediate values must be rounded-up.

Expansion joint

(required for system lengths over 100 m)

Determination of quantity of expansion joints required:

$$n = \frac{L_1}{L}$$

n = Number (integer rounded up)

L₁ = Total system length - 100 m

L = Max. conductor length for each expansion joint (see table)

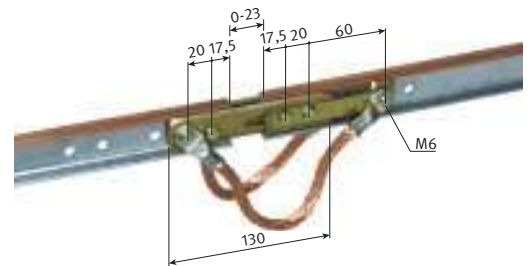

up to Δ t	max. L ⁽¹⁾	up to Δ t	max. L ⁽¹⁾
20 °C	74 m	60 °C	24 m
30 °C	49 m	70 °C	21 m
40 °C	37 m	80 °C	18 m
50 °C	29 m	90 °C	16 m

(1) An unobstructed longitudinal expansion is a requirement for this purpose. The maximum expansion path must be limited to 42 m with heavy particle contamination.

Type	Weight kg	Material	Order no.	Order no.
DLM 20 / 14	0.32	Cu Zn 40 Pb 2	100 160	107 365
DLM 20 / 25	0.35	Cu Zn 40 Pb 2	100 170	107 329
DLM 20 / 50	0.38	Cu Zn 40 Pb 2	100 180	106 327
DLM 20 / 100	0.41	Cu Zn 40 Pb 2	100 190	106 451

Max. support bracket distance to the expansion joint = 250 mm (possibly install additional support brackets)

Rigid joint

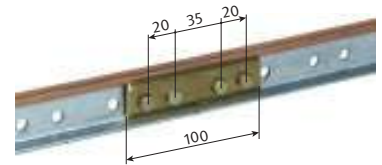
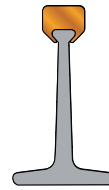

Type	Weight kg	Material	Order no.	Order no.	Stainless steel
BLM 20 / 14-100	0.18	Cu Zn 40 Pb 2	100 510	106 100	

Feeder clamps

The feeder clamps are mounted at the intended feed points of the conductor.

Type Cu must be soldered onto the copperhead of the conductor. Please clean the contact surfaces and apply contact grease.

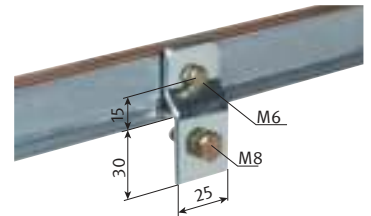

Type	Weight kg	Connection max.	Order no.	Order no.	Stainless steel
Cu 20 / 14	0.06	2 x 35 mm ²	100 600	106 150	
Cu 20 / 25	0.08	2 x 35 mm ²	104 840	106 075	
Cu 20 / 50	0.08	2 x 35 mm ²	104 850	106 151	
Cu 20 / 100	0.09	2 x 35 mm ²	104 860	106 152	

Locating clamps

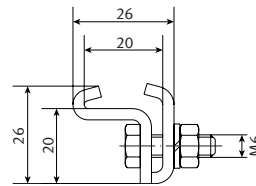

Illustration shows an insulator with 2 locating clamps

Type	Weight kg	Material	Order no.	Order no.	Stainless steel
LK 20	0.04	Galvanized steel	100 550	106 306	

Isolating sections

Type L = Loose delivery as spare part

Type M = Assembly at the factory

Max. support bracket distance to the isolating section = 250 mm

(possibly install additional support brackets)

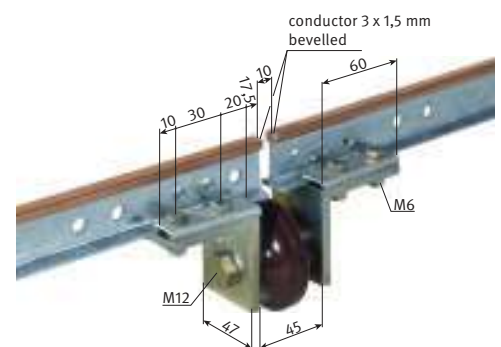

Type	Weight kg	Insulator	Order no.	Order no.	Stainless steel
LT 1 / 20-10-L	0.40	GH 45	106 050	107 340	
LT 1 / 20-10-M	0.40	GH 45	106 051	107 341	

Contact grease for joints and feeder clamps

(see page 38)

Steel-Copperhead conductors F 35

Reference code:

F = Steel T-Profile
 35 = T-profile foot width b in mm
 30 = Copper cross-section (mm²)

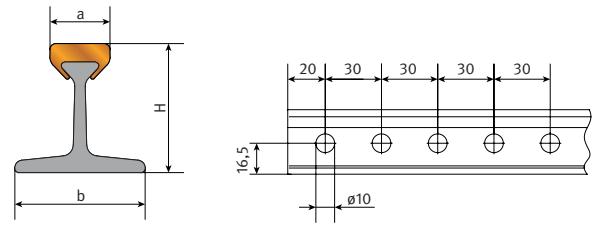

Bending at the factory:

Minimum bending radius: R min. = 1000 mm
 max. support distance: 1000 mm
 Bending over the foot, head and lip is possible
 Bending over the copperhead is not possible with F 35/30

Standard length: 7 m
 Short sections: on request
 Support distance: 2.5 m in straight runs
 Suitable current collectors: GSV 2, GSV 4, GSV 8
 The steel profile can be supplied hot galvanized or coated.

Type	Cross section Copperhead mm ²	Cross section Steel mm ²	Equivalent Total copperhead cross-section mm ²	H mm	a mm	b mm	Weight kg/m	Order no. ⁽¹⁾
F 35 / 30	30	265	69	32.0	14.2	35.0	2.34	104 31•
F 35 / 50	50	265	89	33.1	14.6	35.0	2.52	100 04•
F 35 / 100	100	265	139	36.0	15.3	35.0	2.97	100 05•
F 35 / 150	150	265	189	38.3	17.3	35.0	3.42	100 06•
F 35 / 200	200	265	239	40.8	17.3	35	3.87	100 07•

(1) The last figure of the Ident. no. states the individual length in meters. Please add 1, 2,...7 to the order no. Intermediate values must be rounded up.

Expansion joint

(required for system lengths over 100 m)

Determination of quantity of expansion joints required:

$$n = \frac{L_1}{L}$$

n = Number (integer rounded up)

L₁ = Total system length - 100 m

L = Max. conductor length for each expansion joint (see table)

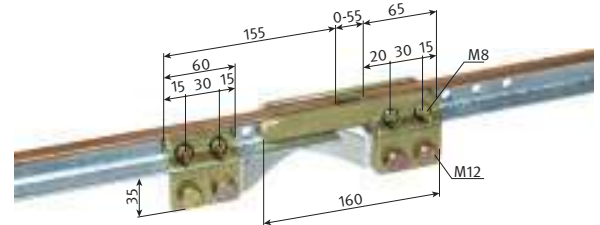

up to Δ t	max. L ⁽¹⁾	up to Δ t	max. L ⁽¹⁾
20 °C	100 m	60 °C	59 m
30 °C	100 m	70 °C	50 m
40 °C	88 m	80 °C	44 m
50 °C	70 m	90 °C	39 m

(1) An unobstructed longitudinal expansion is a requirement for this purpose. The maximum expansion path must be limited to 42 m with heavy particle contamination.

Type	Weight kg	Material	Order no.	Order no.	Stainless steel
SMDV 35 / 30	1.15	Cu Zn 33 Pb 2	104 340	106 221	
SMDV 35 / 50	1.15	Cu Zn 33 Pb 2	100 300	106 222	
SMDV 35 / 100	1.25	Cu Zn 33 Pb 2	100 310	106 223	
SMDV 35 / 150	1.39	Cu Zn 33 Pb 2	100 320	106 224	
SMDV 35 / 200	1.48	Cu Zn 33 Pb 2	100 330	106 225	

Max. support bracket distance to the expansion joint = 250 mm (possibly install additional support brackets)

Rigid joint

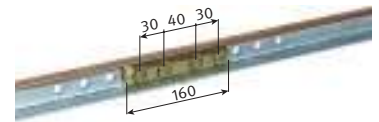
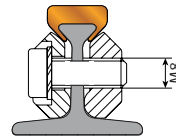

Type	Weight kg	Material	Order no.	Order no.	Stainless steel
MFV 35 / 30-200	0.41	Cu Zn 40 Pb 2	105 893	106 227	

Feeder clamps

The feeder clamps are mounted at the intended feed points of the conductors. Type Cu must be soldered onto the copperhead of the conductor.

Please clean the contact surfaces and apply contact grease.

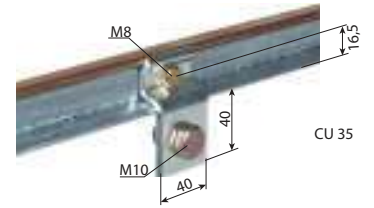
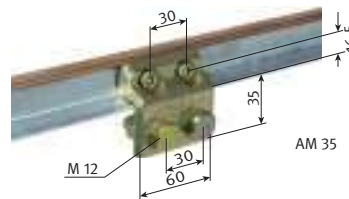

Type	Weight kg	Connection max.	Order no.	Order no.	Stainless steel
AM 35 / 30-200	0.44	4 x 120 mm ²	105 050	106 235	
AM 35 / 30-200-265 lg. ⁽¹⁾	1.95	12 x 150 mm ²	106 621	107 880	
Cu 35 / 30	0.16	2 x 150 mm ²	104 360	106 230	
Cu 35 / 50	0.17	2 x 150 mm ²	100 610	106 231	
Cu 35 / 100	0.18	2 x 150 mm ²	100 620	106 201	
Cu 35 / 150	0.19	2 x 150 mm ²	100 630	106 232	
Cu 35 / 200	0.20	2 x 150 mm ²	100 640	106 233	

(1) not illustrated / 265 mm long connection terminals can be used as rigid joints at the same time

Locating clamps

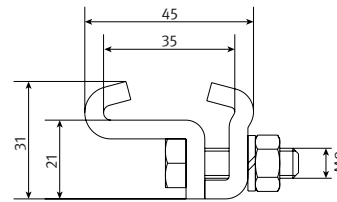

Illustration shows an insulator with 2 locating clamps (fix point)

Type	Weight kg	Material	Order no.	Order no.	Stainless steel
SK 35	0.11	Galvanized steel	100 560	106 237	

Isolating sections

Type L = Loose delivery as spare part

Type M = Assembly at the factory

Max. support bracket distance to the

isolating sections = 250 mm

(possibly install additional support brackets)

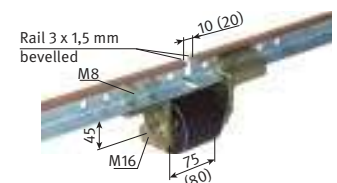

Measures in brackets for 20 mm air gap

Type	Weight kg	Insulator	Order no.	Order no.	Stainless steel
LT 2 / 35-10-L	1.70	GHR 75	106 137	106 585	
LT 2 / 35-10-M	1.70	GHR 75	107 334	107 335	
LT 2 / 35-20-L	1.70	GHR 75	107 336	107 337	
LT 2 / 35-20-M	1.70	GHR75	107 338	107 339	

Contact grease for joints and feeder clamps

(see page 38)

Steel-Copperhead conductors F 45

Reference code:

F = Steel T-profile
 45 = T-profile foot width b in mm
 50 = Copper cross-section (mm²)

Bending at the factory:

Minimum bending radius: R min. = 1000 mm
 max. support distance: 1200 mm

Bending over foot, head and lip is possible

Bending over the copperhead is not possible with F 45/50

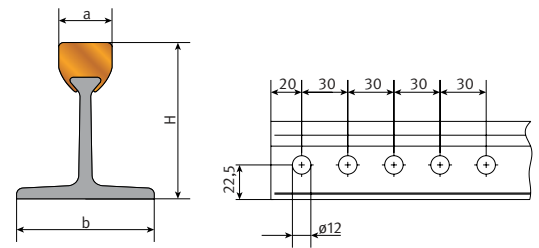

Standard length: 7 m
 Short sections: on request
 Support distance: 2.5 m in straight runs
 Suitable current collectors: GSV 2, GSV 4, GSV 8
 The steel profile can be supplied hot galvanized or coated.

Type	Cross section Copperhead mm ²	Cross section Steel mm ²	Equivalent Total copper cross-section mm ²	H mm	a mm	b mm	Weight kg/m	Order no. ⁽¹⁾
F 45 / 50	50	355	102	43.1	14.6	45.0	3.23	100 08•
F 45 / 100	100	355	152	46.0	15.3	45.0	3.68	100 09•
F 45 / 150	150	355	202	48.3	17.3	45.0	4.13	100 10•
F 45 / 200	200	355	252	50.8	17.3	45.0	4.58	100 11•
F 45 / 300	300	355	352	56.3	17.6	45.0	5.48	100 12•
F 45 / 400	400	355	452	59.3	19.6	45.0	6.38	100 13•
F 45 / 500	500	355	552	64.3	19.6	45.0	7.28	100 14•
F 45 / 600	600	355	652	65.0	23.2	45.0	8.18	100 15•

(1) The last figure of the Ident. no. states the individual length in meters. Please add 1, 2,...7 to the order no. Intermediate values must be rounded-up.

Expansion joint

(required for system lengths over 100 m)

Determination of quantity of expansion joints required:

$$n = \frac{L_1}{L}$$

n = Number (integer rounded up)

L₁ = Total system length - 100 m

L = Max. conductor length for each expansion joint (see table)

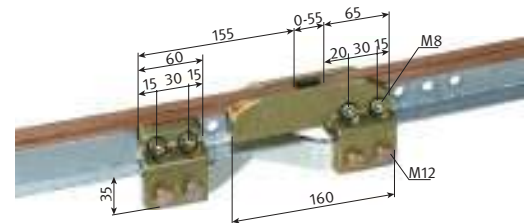

up to Δ t	max. L ⁽¹⁾	up to Δ t	max. L ⁽¹⁾
20 °C	100 m	60 °C	59 m
30 °C	100 m	70 °C	50 m
40 °C	88 m	80 °C	44 m
50 °C	70 m	90 °C	39 m

(1) An unobstructed longitudinal expansion is a requirement for this purpose. The maximum expansion path must be limited to 42 m with heavy particle contamination (e.g. steel mills / foundries).

Type	Weight kg	Material	Order no.	Order no. <small>Stainless steel</small>
SMDV 45 / 50	1.46	Cu Zn 33 Pb	107 744	107 308
SMDV 45 / 100	1.56	Cu Zn 33 Pb	107 745	107 127
SMDV 45 / 150	1.69	Cu Zn 33 Pb	107 746	107 310
SMDV 45 / 200	1.80	Cu Zn 33 Pb	107 747	107 311
SMDV 45 / 300	3.06	Cu Zn 33 Pb	100 380	106 144
SMDV 45 / 400	3.29	Cu Zn 33 Pb	100 390	106 109
SMDV 45 / 500	3.51	Cu Zn 33 Pb	100 400	106 145
SMDV 45 / 600	3.78	Cu Zn 33 Pb	100 410	106 146

Steel mills: max. expansion joint distance 42 m
 Max. support bracket distance to the expansion joint = 250 mm (possibly install additional support brackets)

Expansion joint

with increased expansion value (e.g. building expansion joint)
(required for system lengths over 100 m)

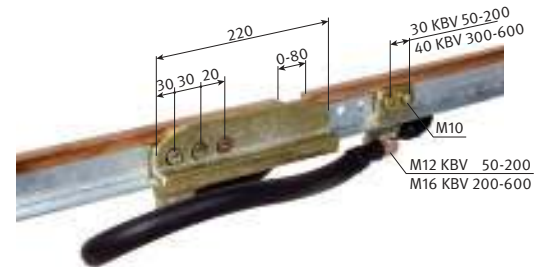

Type	Weight kg	Material	Order no.	Order no.	Stainless steel
KBV 45 / 50	3.61	Cu Zn 33 Pb	100 420	106 238	
KBV 45 / 100	3.98	Cu Zn 33 Pb	100 430	106 239	
KBV 45 / 150	4.70	Cu Zn 33 Pb	100 440	106 240	
KBV 45 / 200	4.90	Cu Zn 33 Pb	100 450	106 241	
KBV 45 / 300	7.59	Cu Zn 33 Pb	100 460	106 242	
KBV 45 / 400	7.76	Cu Zn 33 Pb	100 470	106 243	
KBV 45 / 500	7.94	Cu Zn 33 Pb	100 480	106 244	
KBV 45 / 600	8.01	Cu Zn 33 Pb	100 490	106 245	

Max. support bracket distance to the expansion joint = 250 mm (possibly install additional support brackets)

Rigid joint

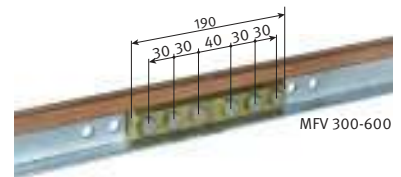
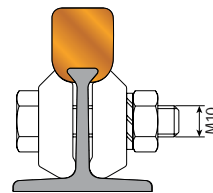
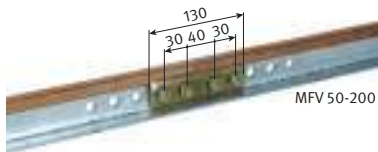
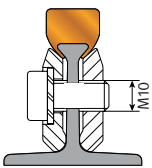

Type	Weight kg	Material	Order no.	Order no.	Stainless steel
MFV 45 / 50-200	0.46	Cu Zn 40 Pb 2	105 897	106 089	
MFV 45 / 300-600	1.28	Cu Zn 40 Pb 2	100 540	106 063	

Contact grease for joints and feeder clamps

(see page 38)

Feeder clamps

The feeder clamps are mounted at the intended feed points of the conductors. Type Cu must be soldered onto the copperhead of the conductor. Please clean the contact surfaces and apply contact grease.

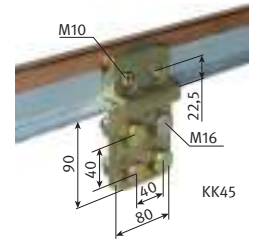
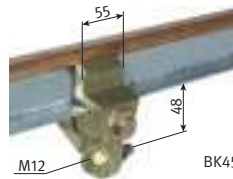
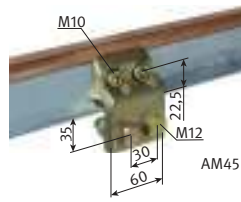
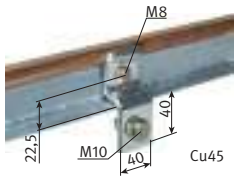

Type	Connection max.	Weight kg	Order no.	Order no. <small>Stainless steel</small>
Cu 45 / 50	2 x 150 mm ²	0.20	100 650	106 088
Cu 45 / 100	2 x 150 mm ²	0.21	100 660	106 077
Cu 45 / 150	2 x 150 mm ²	0.22	100 670	106 131
Cu 45 / 200	2 x 150 mm ²	0.22	100 680	106 153
AM 45 / 50–200	4 x 120 mm ²	0.60	107 743	107 317
AM 45 / 50–200–265 lg. ⁽¹⁾	12 x 150 mm ²	2.20	105 987	106 359
AM 45 / 300–600–265 lg. ⁽¹⁾	12 x 150 mm ²	3.32	105 922	106 212
BK 45 / 50–200	2 x 95 mm ²	1.29	100 700	106 110
BK 45 / 300–600	2 x 95 mm ²	1.29	103 460	103 470
KK 45 / 300	4 x 185 mm ²	1.26	100 710	106 219
KK 45 / 400	4 x 185 mm ²	1.89	104 760	106 246
KK 45 / 500	4 x 185 mm ²	1.89	104 770	106 247
KK 45 / 600	4 x 185 mm ²	1.89	104 780	106 248

(1) not illustrated / 265 mm long feeder clamps can be used as rigid joints at the same time

Locating clamps

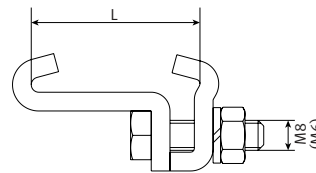

Illustration shows an insulator with 2 locating clamps (fix point)

Type	Weight kg	Material	Order no.	Order no. <small>Stainless steel</small>
SK 45	0.12	Galvanized steel	100 570	106 078

Isolating sections

Type L = Loose delivery as spare part

Type M = Assembly at the factory

Max. support bracket distance to the

isolating section = 250 mm

(possibly install additional support brackets)

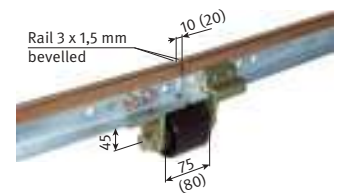

Value in brackets for 20 mm air gap

Type	Weight kg	Insulator	Order no.	Order no. <small>Stainless steel</small>
LT 2 / 45–10–L	1.70	GHR 75	105 777	106 343
LT 2 / 45–10–M	1.70	GHR 75	107 332	107 333
LT 2 / 45–20–L	1.70	GHR 75	105 942	106 220
LT 2 / 45–20–M	1.70	GHR75	107 330	107 331

Aluminium-Copperhead conductors A 20

Reference code:

A = Aluminum T-profile
 20 = T-profile foot width b in mm
 14 = Copper cross-section (mm²)

Bending at the factory:

Minimum bending radius: R min. = 600 mm
 max. support distance: 600 mm

Bending over the foot and lip is possible

Bending over the copperhead is not possible with A 20/14

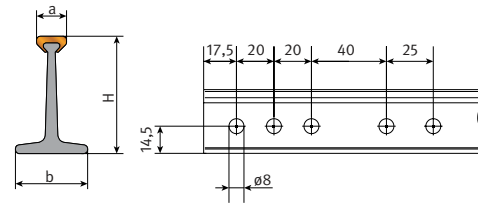

Standard length: 7 m
 Short sections: on request
 Support distance: 2 m in straight runs
 Suitable current collectors: DVD, GSV 1

Type	Cross section Copper head mm ²	Cross section Steel mm ²	Equivalent Total copper cross-section m ²	H mm	a mm	b mm	Weight kg/m	Order no. ⁽¹⁾
A 20 / 14	14	150	90	31.0	6.5	20.0	0.52	103 64•

⁽¹⁾ The last figure of the Ident. no. states the individual length in meters. Please add 1, 2,...,7 to the order no. Intermediate values must be rounded up.

Expansion joint

(required for system lengths over 100 m)

Determination of quantity of expansion joints required:

$$n = \frac{L_1}{L}$$

n = Number (integer rounded up)

L₁ = Total system length - 100 m

L = Max. conductor length for each expansion joint

(see table)

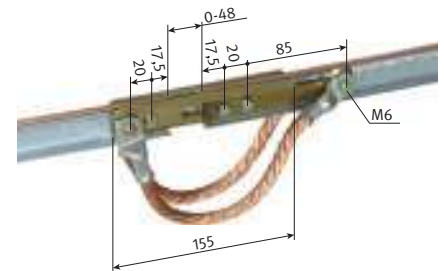

up to Δ t	max. L ⁽¹⁾	up to Δ t	max. L ⁽¹⁾
20 °C	100 m	60 °C	40 m
30 °C	80 m	70 °C	34 m
40 °C	60 m	80 °C	30 m
50 °C	48 m	90 °C	26 m

⁽¹⁾ An unobstructed longitudinal expansion is a requirement for this purpose. The maximum expansion path must be limited to 42 m with heavy particle contamination.

Type	Weight kg	Material	Order no.	Order no. ^{Stainless steel}
DMA 20 / 14	0.43	Cu Zn 40	103 720	107 659

Max. support bracket distance to the expansion joint = 250 mm (possibly install additional support brackets)

Rigid joint

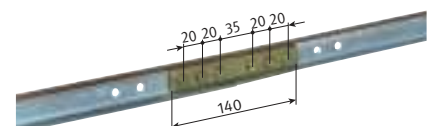
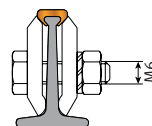

Type	Weight kg	Material	Order no.	Order no. ^{Stainless steel}
ALM 20 / 14	0.26	Cu Zn 40 Pb 2	101 020	107 403

Feeder clamp

The feeder clamps are mounted at the intended feed points of the conductors.

Type Cu must be soldered onto the copperhead of the conductor.

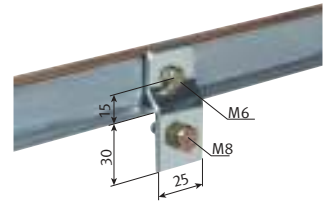

Type ⁽¹⁾	Weight kg	Connection max.	Order no.	Order no.	Stainless steel
Cu 20 / 14	0.14	2 x 35 mm ²	100 600	106 150	

Locating clamp

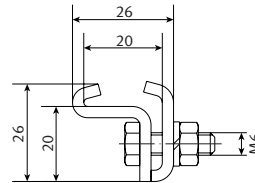

Illustration shows an insulator with 2 locating clamps (fix point)

Type	Weight kg	Material	Order no.	Order no.	Stainless steel
LK 20	0.04	Galvanized steel	100 550	106 306	

Isolating sections

Type L = Loose delivery as spare part

Type M = Assembly at the factory

Max. support bracket distance to the isolating section = 250 mm
(possibly install additional support brackets)

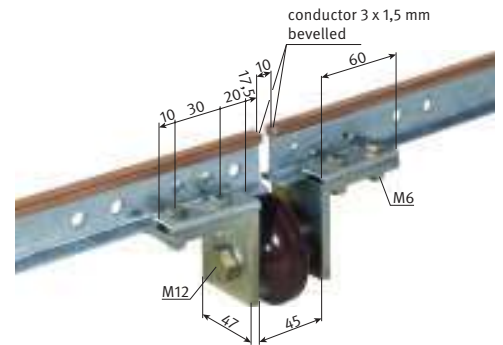

Type	Weight kg	Insulator	Order no.	Order no.	Stainless steel
LT 1 / 20-10-L	0.40	GH 45	106 050	107 340	
LT 1 / 20-10-M	0.40	GH 45	106 051	107 341	

Contact grease for joints and feeder clamps

(see page 38)

Aluminium-Copperhead conductors A 35

Reference code:

A = Aluminum T-profile
 35 = T-profile foot width b in mm
 30 = Copper cross-section (mm²)

Bending at the factory:

Minimum bending radius: R min. = 1000 mm
 max. support distance: 1000 mm

Bending over the foot, head and lip is possible

Bending over the copperhead is not possible with A 35/30

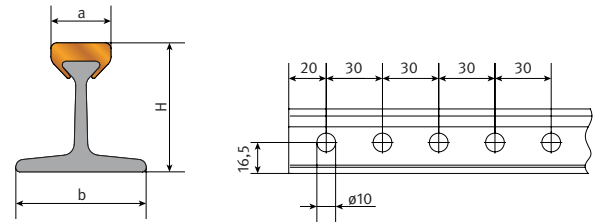

Standard length: 7 m
 Short sections: on request
 Support distance: 2.5 m in straight runs
 Suitable current collectors: GSV 2

Type ⁽¹⁾	Cross section Copper head mm ²	Cross section Steel mm ²	Equivalent Total Copper cross-section mm ²	H mm	a mm	b mm	Weight kg/m	Order no. ⁽¹⁾
A 35 / 30	30	265	160	32.0	14.2	35.0	1.00	104 32•
A 35 / 50	50	265	180	33.1	14.6	35.0	1.18	103 65•
A 35 / 100	100	265	230	36.0	15.3	35.0	1.63	103 66•

(1) The last figure of the Ident. no. states the individual length in metres. Please add 1, 2,...,7 to the order no. Intermediate values must be rounded-up.

Expansion joint

(required for system lengths over 100 m)

Determination of quantity of expansion joints required:

$$n = \frac{L_1}{L}$$

n = Number (integer rounded up)

L₁ = Total system length - 100 m

L = Max. conductor length for each expansion joint

(see table)

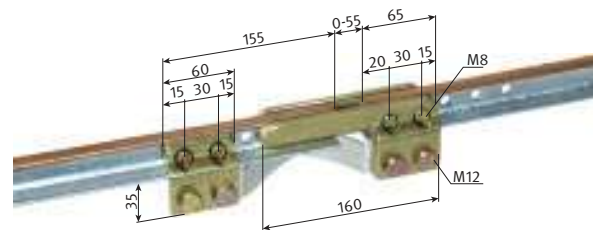

up to Δ t	max. L ⁽¹⁾	up to Δ t	max. L ⁽¹⁾
20 °C	100 m	60 °C	45 m
30 °C	91 m	70 °C	39 m
40 °C	68 m	80 °C	34 m
50 °C	55 m	90 °C	30 m

(1) An unobstructed longitudinal expansion is a requirement for this purpose. The maximum expansion path must be limited to 42 m with heavy particle contamination.

Type	Weight kg	Material	Order no.	Order no. Stainless steel
SMDA 35 / 30	1.42	Cu Zn 40 Pb	104 350	106 791
SMDA 35 / 50	1.52	Cu Zn 40 Pb	103 780	107 859
SMDA 35 / 100	1.71	Cu Zn 40 Pb	103 790	107 860

Max. support bracket distance to the expansion joint = 250 mm (possibly install additional support brackets)

Rigid joint

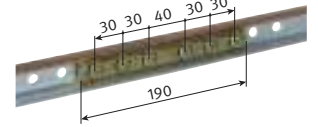
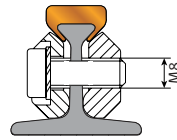

Type	Weight kg	Material	Order no.	Order no.	Stainless steel
MFVA 35 / 30-100	0.59	Cu Zn 40 Pb 2	105 903	106 697	

Feeder clamps

The feeder clamps are mounted at the intended feed points of the conductors. Please clean the contact surfaces and apply contact grease.

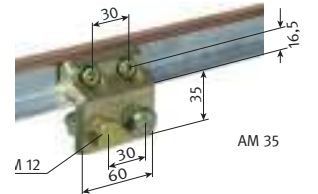

Type	Weight kg	Connection max.	Order no.	Order no.	Stainless steel
AM 35 / 30-200	0.44	4 x 120 mm ²	105 050	106 235	
AM 35 / 30-200-265 ⁽¹⁾	1.95	12 x 150 mm ²	106 621	107 880	

(1) not illustrated / 265 mm long connection terminals can be used as rigid joints at the same time

Locating clamps

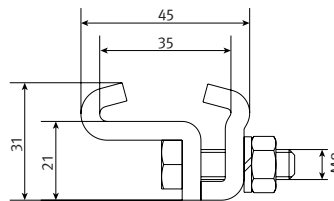

Illustration shows an insulator with 2 locating clamps

Type	Weight kg	Material	Order no.	Order no.	Stainless steel
SK 35	0.11	Galvanized steel	100 560	106 237	

Isolating sections

Type L = Loose delivery as spare part

Type M = Assembly at the factory

Max. support bracket distance to the isolating section = 250 mm (possibly install additional support brackets)

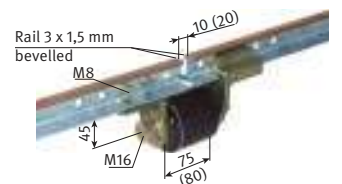

Measures in brackets for 20 mm air gap

Type	Weight kg	Insulator	Order no.	Order no.	Stainless steel
LT 2 / 35-10-L	1.70	GHR 75	106 137	106 585	
LT 2 / 35-10-M	1.70	GHR 75	107 334	107 335	
LT 2 / 35-20-L	1.70	GHR 75	107 336	107 337	
LT 2 / 35-20-M	1.70	GHR 75	107 338	107 339	

Contact grease for joints and feeder clamps

(see page 38)

Aluminium-Copperhead conductors A 45

Reference code:

A = Aluminum T-profile
 45 = T-profile foot width b in mm
 50 = Copper cross-section (mm²)

Bending at the factory:

Minimum bending radius: R min. = 1000 mm
 max. support distance: 1200 mm

Bending over the foot, head and lip is possible

Bending via the copperhead is not possible with A 45/50

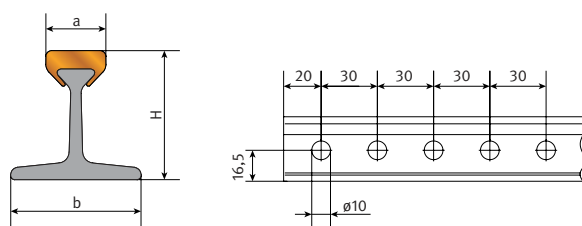

Standard length: 7 m
 Short sections: on request
 Support distance: 2.5 m in straight runs
 Suitable current collectors: GSV 2, GSV 4, GSV 8

Type	Cross section Copper head mm ²	Cross section Steel mm ²	Equivalent Total copper cross-section mm ²	H mm	a mm	b mm	Weight kg/m	Order no. ⁽¹⁾
A 45 / 50	50	355	255	43.1	14.6	45.0	1.42	103 67•
A 45 / 100	100	355	275	46.0	15.3	45.0	1.87	103 68•
A 45 / 150	150	355	325	48.3	17.3	45.0	2.32	103 69•
A 45 / 200	200	355	375	50.8	17.3	45.0	2.77	103 58•
A 45 / 300	300	355	475	56.3	17.6	45.0	3.67	103 70•
A 45 / 400	400	355	575	59.3	19.6	45.0	4.57	103 71•

(1) The last figure of the Ident. no. states the individual length in metres. Please add 1, 2,...,7 to the order no. Intermediate values must be rounded-up.

Expansion joint

(required for system lengths over 100 m)

Determination of quantity of expansion joints required:

$$n = \frac{L_1}{L}$$

n = Number (integer rounded up)

L₁ = Total system length - 100 m

L = Max. conductor length for each expansion joint (see table)

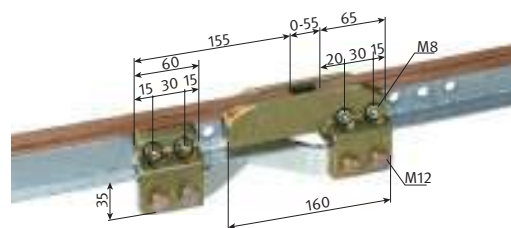

up to Δ t	max. L ⁽¹⁾	up to Δ t	max. L ⁽¹⁾
20 °C	100 m	60 °C	45 m
30 °C	91 m	70 °C	39 m
40 °C	68 m	80 °C	34 m
50 °C	55 m	90 °C	30 m

(1) An unobstructed longitudinal expansion is a requirement for this purpose. The maximum expansion path must be limited to 42 m with heavy particle contamination.

Type	Weight kg	Material	Order no.	Order no. <small>Stainless steel</small>
SMDA 45 / 50	1.91	Cu Zn 33 Pb 2	103 800	106 317
SMDA 45 / 100	2.79	Cu Zn 33 Pb 2	103 810	106 328
SMDA 45 / 150	3.18	Cu Zn 33 Pb 2	103 820	106 692
SMDA 45 / 200	3.18	Cu Zn 33 Pb 2	105 679	106 590
SMDA 45 / 300	3.81	Cu Zn 33 Pb 2	103 830	107 861
SMDA 45 / 400	3.87	Cu Zn 33 Pb 2	103 840	106 181

Max. support bracket distance to the expansion joint = 250 mm (possibly install additional support brackets)

Expansion joint

with increased expansion value
(e.g. building expansion joint)

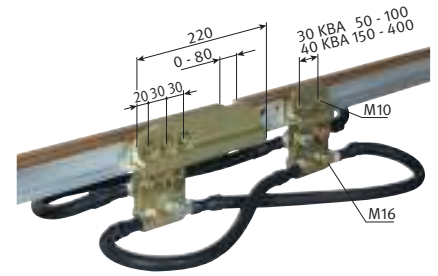

Type	Weight kg	Material	Order no.	Order no.	Stainless steel
KBA 45 / 50	3.86	Cu Zn 40 Pb 2	103 850	107 459	
KBA 45 / 100	4.00	Cu Zn 40 Pb 2	103 860	107 460	
KBA 45 / 150	6.94	Cu Zn 40 Pb 2	103 870	107 469	
KBA 45 / 200	6.86	Cu Zn 40 Pb 2	105 680	107 470	
KBA 45 / 300	7.93	Cu Zn 40 Pb 2	103 880	107 471	
KBA 45 / 400	8.01	Cu Zn 40 Pb 2	103 890	107 472	

Max. support bracket distance to the expansion joint = 250 mm (possibly install additional support brackets)

Rigid joint

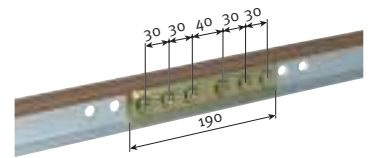
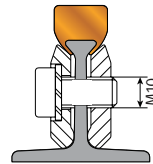

Type	Weight kg	Material	Order no.	Order no.	Stainless steel
MFVA 45 / 50-200	0.66	Cu Zn 40 Pb 2	105 150	106 329	
MFVA 45 / 300-400	1.28	Cu Zn 40 Pb 2	105 160	106 594	

Feeder clamps

The feeder clamps are mounted at the intended feed points of the conductors.
Please clean the contact surfaces and apply contact grease.

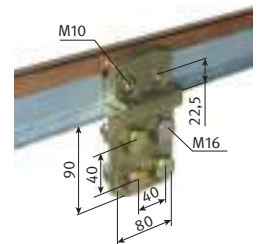

Type	Weight kg	Connection max.	Order no.	Order no.	Stainless steel
KKA 45 / 50	1.26	2 x 185 mm ²	104 790	106 848	
KKA 45 / 100	1.26	2 x 185 mm ²	104 800	106 330	
KKA 45 / 150	1.89	4 x 185 mm ²	104 810	106 694	
KKA 45 / 200	1.89	4 x 185 mm ²	105 130	106 591	
KKA 45 / 300	1.89	4 x 185 mm ²	104 820	107 473	
KKA 45 / 400	1.89	4 x 185 mm ²	104 830	106 592	
AM 45 / 50-200-265 lg. ⁽¹⁾	2.20	12 x 150 mm ²	105 987	106 359	
AM 45 / 300-600-265 lg. ⁽¹⁾	3.32	12 x 150 mm ²	105 922	106 212	

(1) not illustrated / 265 mm long connection terminals can be used as rigid joints at the same time

Locating clamps

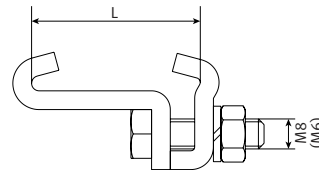

Illustration shows an insulator with 2 locating clamps (fix point)

Type	Weight kg	Material	Order no.	Order no.	Stainless steel
SK 45	0.12	Galvanized steel	100 570	106 078	
SKK 45 ⁽¹⁾	0.23	Plastic	100 580	106 249	

(1) Not illustrated

Isolating sections

Type L = Loose delivery as spare part

Type M = Assembly at the factory

Max. support bracket distance to the isolating section = 250 mm
(possibly install additional support brackets)

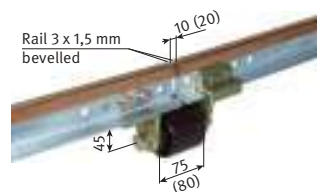

Value in brackets for 20 mm air gap

Type	Weight kg	Insulator	Order no.	Order no.	Stainless steel
LT 2 / 45-10-L	1.70	GHR 75	105 777	106 343	
LT 2 / 45-10-M	1.70	GHR 75	107 332	107 333	
LT 2 / 45-20-L	1.70	GHR 75	105 942	106 220	
LT 2 / 45-20-M	1.70	GHR 75	107 330	107 331	

Contact grease for joints and feeder clamps

(see page 38)

Solid copper conductors C

Reference code:

C = Solid copper conductor
 45 = Conductor foot width b in mm
 200 = Copper cross-section (mm²)

Bending at the factory:

C 20/200 Minimum bending radius: R min. = 600 mm
 max. support distance: 600 mm

C 35/45 Minimum bending radius: R min. 1000 mm
 max. support distance C 35: 1000 mm
 C 45: 1200 mm
 C 60: 1500 mm

Conductor bending over the foot, head and lip is possible

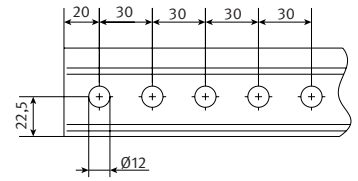
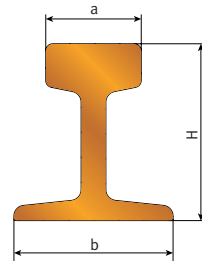

Standard length: 7 m
 Short sections: on request
 Support distance: in straight runs
 C 20/ 200 = 2.0 m
 C 35/ 400 = 2.5 m
 C 45/ C 60 = 2.5 m

Suitable current collectors for C 20/200: DVD, GSV1
 Suitable current collectors for C 35, C 45 : GSV 2, GSV 4, GSV 8
 Suitable current collectors for C 60 : GSV 4, GSV 8

Type	Cross section copper head mm ²	H mm	a mm	b mm	Weight kg/m	Order no. ⁽¹⁾
C 20 / 200	200	32	12	20	1.86	100 82•
C 35 / 400	400	45	12	35	3.55	100 83•
C 45 / 500	500	50	16	45	4.45	100 93•
C 45 / 600	600	50	25	45	5.32	100 84•
C 45 / 800	800	50	27	45	7.12	100 85•
C 60 / 1000	1000	53	30	60	9.01	108 62•
C 60 / 1200	1200	60	30	60	10.81	107 68•

(1) The last figure of the Ident. no. states the individual length in metres. Please add 1, 2,...,7 to the order no. Intermediate values must be rounded up.

Expansion joint

(required for system lengths over 100 m)

For determination of quantity of expansion joints, see page 24

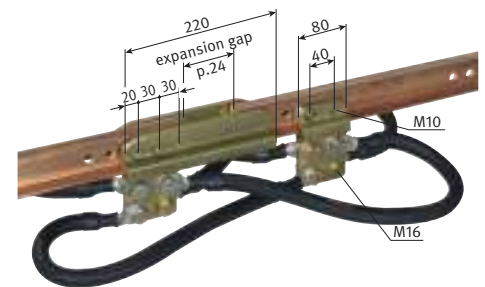

Type	Weight kg	Material	Order no.	Order no. <small>Stainless steel</small>
DP 20 / 200	1.01	G-Cu Zn 33 Pb	100 960	106 640
DP 35 / 400	2.56	G-Cu Zn 33 Pb	100 970	106 331
DP 45 / 500	7.00	G-Cu Zn 33 Pb	100 940	106 543
DP 45 / 600	7.80	G-Cu Zn 33 Pb	107 191	107 240
DP 45 / 800	8.50	G-Cu Zn 33 Pb	100 990	106 355
DP 60 / 1000 ⁽¹⁾	13.10	G-Cu Zn 33 Pb	108 616	108 617
DP 60 / 1200 ⁽¹⁾	13.50	G-Cu Zn 33 Pb	107 721	107 710

(1) Version with Cu

Max. support bracket distance to the expansion joint = 250 mm (possibly install additional support brackets)

Expansion joint

Determination of quantity of expansion joints required:

$$n = \frac{L_1}{L}$$

n = Number (integer rounded up)

L₁ = Total system length - 100 m

L = Max. conductor length for each expansion joint
(see table)

Expansion C 20

up to Δ t	max. L ⁽¹⁾	up to Δ t	max. L
20 °C	73 m	60 °C	24 m
30 °C	46 m	70 °C	21 m
40 °C	36 m	80 °C	18 m
50 °C	29 m	90 °C	16 m

Expansion C 35 and C60

up to Δ t	max. L ⁽¹⁾	up to Δ t	max. L
20 °C	100 m	60 °C	53 m
30 °C	100 m	70 °C	46 m
40 °C	80 m	80 °C	40 m
50 °C	64 m	90 °C	35 m

Expansion C 45

up to Δ t	max. L ⁽¹⁾	up to Δ t	max. L
20 °C	100 m	60 °C	78 m
30 °C	100 m	70 °C	67 m
40 °C	100 m	80 °C	58 m
50 °C	94 m	90 °C	52 m

Expansion joint, available expansion dimension

Type	Expansion dimension
DP 20 / 200	0-25 mm
DP 35 / 400	0-55 mm
DP 45 / 500	0-80 mm
DP 45 / 600	0-80 mm
DP 45 / 800	0-80 mm
DP 60 / 1000	0-55 mm
DP 60 / 1200	0-55 mm

(1) An unobstructed longitudinal expansion is a requirement for this purpose. The maximum expansion path must be limited to 42 m with heavy particle contamination (e.g. steel mills / foundries).

Rigid joints

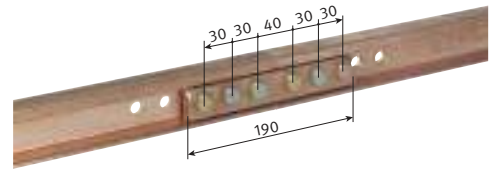
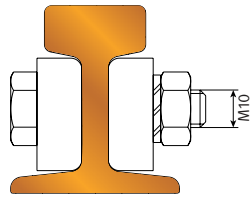

Type	Weight kg	Material	Order no.	Order no.	Stainless steel
CP 20 / 200	0.20	Cu	101 100	106 349	
CP 35 / 400	0.50	Cu	101 110	106 332	
CP 45 / 500	1.15	Cu	100 950	106 542	
CP 45 / 600	1.15	Cu	101 120	106 500	
CP 45 / 800	1.33	Cu	101 130	106 498	
CP 60 / 1000–1200	2.22	Cu	107 723	107 709	

Feeder clamps

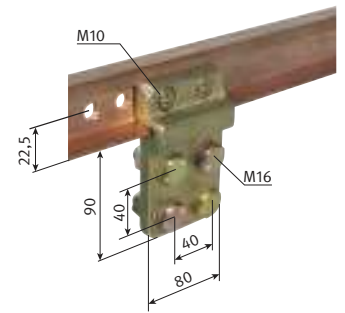

Type	Weight kg	Connection max.	Order no.	Order no.	Stainless steel
CKK 20 / 200	0.25	2 x 70 mm ²	101 140	106 350	
CKK 35 / 400	1.50	4 x 120 mm ²	101 150	106 333	
CKK 45 / 500	1.95	2 x 185 mm ²	101 500	106 544	
CKK 45 / 500–265 lg. ⁽¹⁾	3.55	12 x 128 mm ²	106 676	107 999	
CKK 45 / 600	1.95	4 x 185 mm ²	101 160	106 649	
CKK 45 / 800	1.95	4 x 185 mm ²	101 170	106 499	
CKK 45 / 800–265 lg. ⁽¹⁾	3.64	12 x 185 mm ²	106 675	108 025	
CKK 60 / 1000–1200	2.16	6 x 185 mm ²	108 036	108 037	

(1) not illustrated / 265 mm long feeder clamps can be used as rigid joints at the same time

Locating clamps

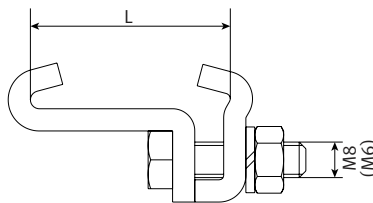

Type	Weight kg	L	Material	Order no.	Order no.	Stainless steel
LK 20	0.04	20	Galvanized steel	100 550	106 306	
SK 35	0.11	35	Galvanized steel	100 560	106 237	
SK 45	0.12	45	Galvanized steel	100 570	106 078	
SK 60	0.15	60	Galvanized steel	107 729	107 711	

Isolating sections

Type L = Loose delivery as spare part

Type M = Assembly in the factory

Max. support bracket distance to the isolating section = 250 mm
(possibly install additional support brackets)

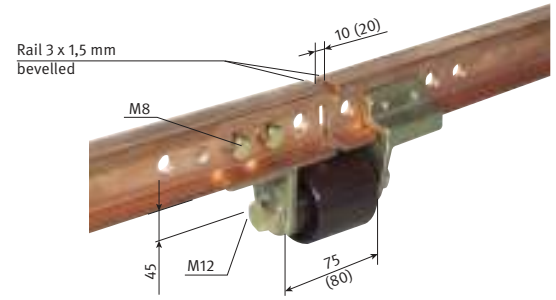

Measures in brackets for 20 mm air gap

Type	Weight kg	Insulator	Order no.	Order no.	Stainless steel
LT 1 / 20-10-L	0.40	GH 45	106 050	107 340	
LT 1 / 20-10-M	0.40	GH 45	106 051	107 341	
LT 1 / 35-10-L	1.40	GHR 75	106 047	-	
LT 1 / 35-10-M	1.40	GHR 75	106 042	-	
LT 2 / 45-10-L	1.70	GHR 75	107 344	107 345	
LT 2 / 45-10-M	1.70	GHR 75	107 346	107 347	
LT 2 / 45-20-L	1.70	GHR 75	107 348	107 349	
LT 2 / 45-20-M	1.70	GHR 75	107 350	107 351	
LT 2 / 60-20-L	2.63	GHR 75	107 652	107 714	
LT 2 / 60-20-M	2.63	GHR 75	107 653	107 654	

Contact grease for joints and feeds

(see page 38)

Insulators with rail holder

Type	Weight kg	Leakage distance mm	Conductor arrangement	Material	max. ambient temperature °C	for conductors with foot width b mm	Order no. short bolts		Order no. long bolts	
							Phase (white)	PE (brown)	Phase (white)	PE (brown)
VDK 20	0.04	60	⊥ T ⊥	PVC	80	20	101 780	101 790	–	–
D 80	0.61	60	T ⊥	Porcelain	100	20	101 380	101 390	–	–
VDK 35	0.17	160	⊥ T ⊥	PVC	80	35	101 800	101 810	–	–
VDO 35	1.20	60	⊥ T ⊥	Porcelain	100	35	105 669	105 670	101 580	101 590
VDB 35	1.49	100	⊥ ⊥	Porcelain	100	35	105 675	105 676	101 620	101 630
VDK 45	0.45	160	⊥ T ⊥	PVC	80	45	106 829 (black)	106 896 (yellow)	106 828 (black)	106 898 (yellow)
VDO 45	1.22	60	⊥ T ⊥	Porcelain	100	45	105 671	105 672	101 660	101 670
VDB 45	1.55	100	⊥ ⊥	Porcelain	100	45	105 677	105 678	101 700	101 710
VCB 45 ⁽¹⁾	2.02	100	⊥ ⊥	Porcelain	100	45	107 941	107 942	107 155	107 940
VDB 60	1.75	100	⊥ ⊥	Porcelain	100	60	107 649	107 650	–	–

When installing in slotted holes, use washers in accordance with DIN EN ISO 7093 on both sides.
 (1) To be applied only for the following conductors: A45/50-400, F45/50-200 and C45/500
 Stainless steel bolts on request

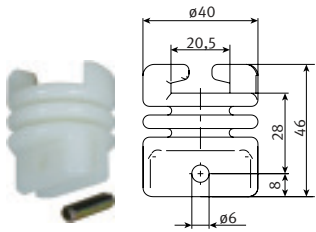

VDK20

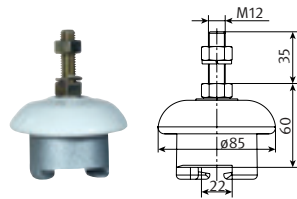

D80

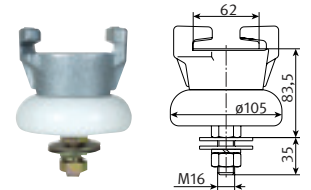

VDB60

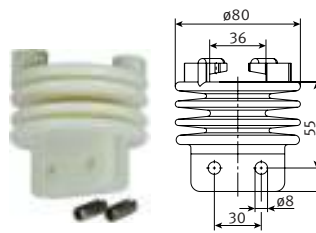

VDK35

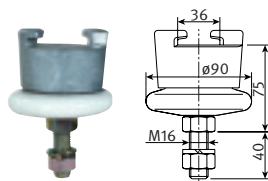

VDO35

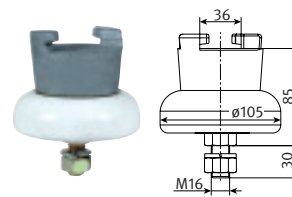

VDB35

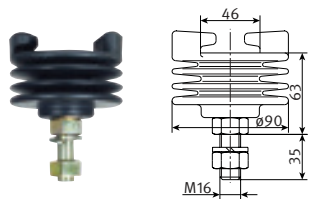

VDK45

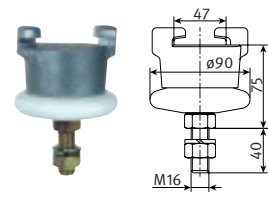

VDO45

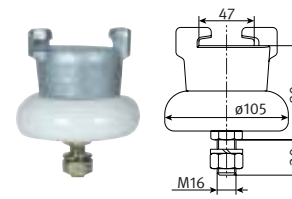

VDB45

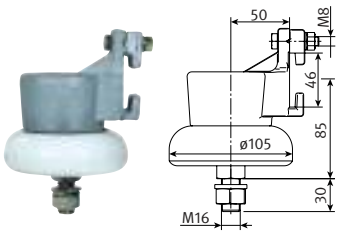

VCB45

Insulators without rail holder

Type	Weight kg	Leakage dis- tance mm	Conductor arrange- ment	Strength (N)		Material	max. ambi- ent tempe- rature °C	Order no. short bolts		Order no. long bolts		Color
				tensile	canti- lever			Phase	PE	Phase	PE	
VO	1.02	60	⊥ T →	–	–	Porcelain	100	105 667	105 668	101 400	101 410	Phase-white PE–brown
VAB	1.51	100	⊥ →	–	–	Porcelain	100	105 673	105 674	101 440	101 450	
VHB	1.51	100	T →	–	–	Porcelain	100	101 520	101 530	112 900	105 572	
VRH	0.71	170	T →	–	–	Porcelain	100	106 407	–	–	–	
MV 52	0.29	65	⊥ T →	–	–	Quartz	350	107 945	–	107 946	–	Phase-brown PE–yellow
MV 65	0.51	80	⊥ T →	–	–	Quartz	350	107 943	–	107 944	–	
MV 261	0.90	100	⊥ T →	–	–	Quartz	350	107 985	–	–	–	
GHH 30	0.16	69	T →	7000	1200	Cast resin	80	106 090	106 091	–	–	
GH 45	0.26	64	⊥ T →	9500	1800	Cast resin	80	101 820	101 830	–	–	Phase-brown PE–yellow
GH 50	0.56	87	⊥ T →	13000	1800	Cast resin	80	101 840	101 850	–	–	
GHA 75	0.64	111	⊥ →	15000	3600	Cast resin	80	101 900	101 910	–	–	
GHH 75	0.64	111	T →	15000	3600	Cast resin	80	101 880	101 890	–	–	
GH 80	0.82	116	⊥ T →	22300	5200	Cast resin	80	101 860	101 870	–	–	
GHA 80	0.87	135	⊥ →	21500	4400	Cast resin	80	104 650	104 660	–	–	
GHH 80	0.87	135	T →	21500	4400	Cast resin	80	104 630	104 640	–	–	

When installing in slotted holes, use washers in accordance with DIN EN ISO 7093 on both sides.
Stainless steel bolts on request

Insulators without rail holder

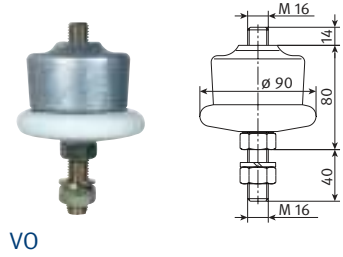

VO

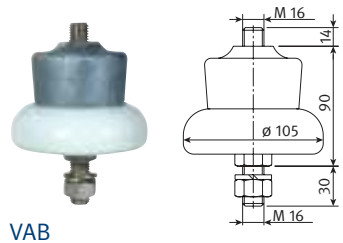

VAB

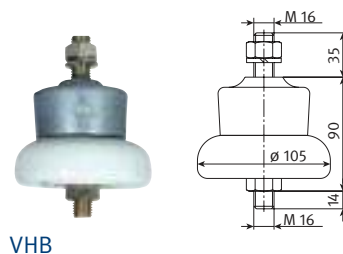

VHB

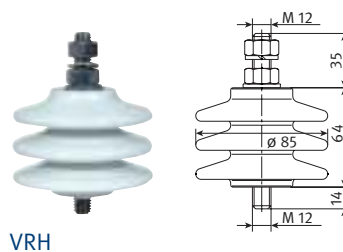

VRH

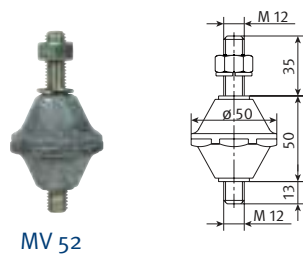

MV 52

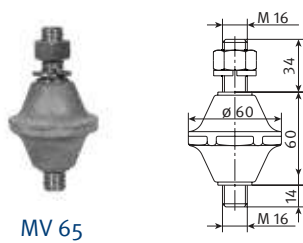

MV 65

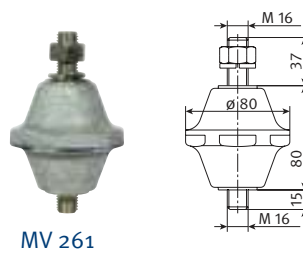

MV 261

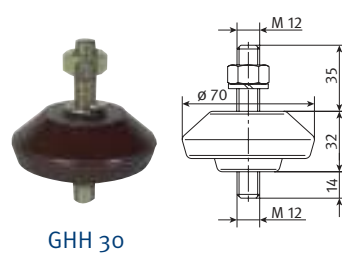

GHH 30

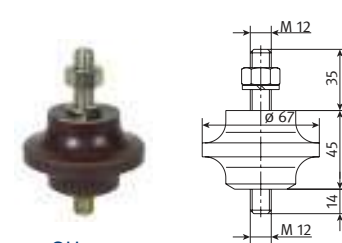

GH 45

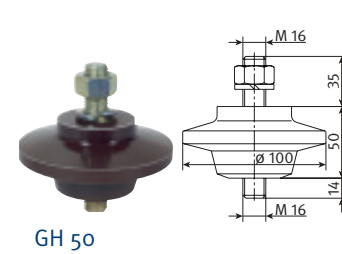

GH 50

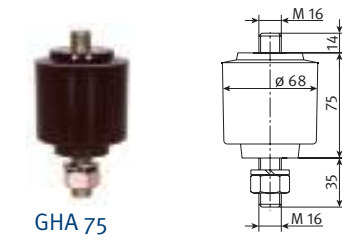

GHA 75

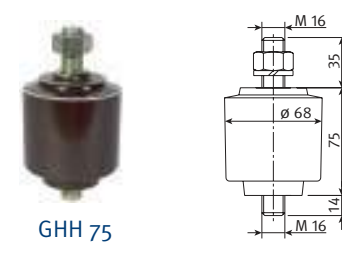

GHH 75

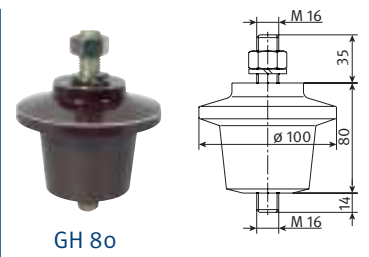

GH 80

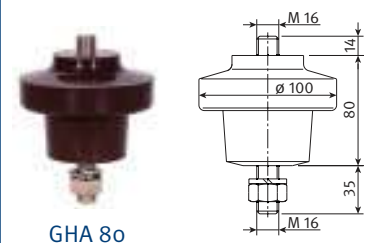

GHA 80

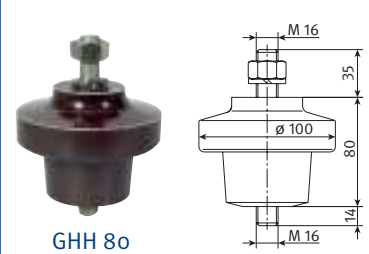

GHH 80

Rail holder

Type	Weight kg	Strength (N)		Material	max. ambient temperature °C	for conductors with foot width b mm	Order no.
		tensile	cantilever				
SD 20	0.15	–	–	Grey cast iron	200	20	101 180
SD 35	0.20	–	–	Grey cast iron	200	35	101 190
SH 35	0.36	–	–	Grey cast iron	200	35	101 200
SC 35	0.57	–	–	Grey cast iron	200	35	101 230
SA 35	0.23	–	–	Aluminum	150	35	107 630
SKD 35	0.05	–	–	Plastic	80	35	101 220
SD 45	0.21	–	–	Grey cast iron	200	45	101 240
SH 45	0.36	–	–	Grey cast iron	200	45	101 250
SC 45	0.57	–	–	Grey cast iron	200	45	101 280
SA 45	0.23	–	–	Aluminum	150	45	104 600
SKD 45	0.07	–	–	Plastic	80	45	101 270
SSR 45	0.45	–	–	Stainless steel	200	45	104 730

For A-type conductors use conductor holders SA or SKD only.
When installing in slotted holes, use washers in accordance with DIN EN ISO 7093 on both sides.
Stainless steel bolts on request

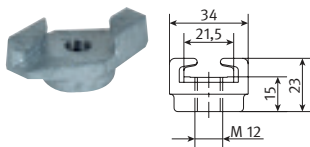

SD 20

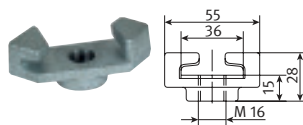

SD 35

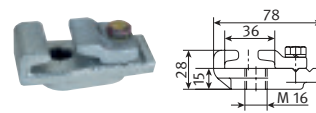

SH 35

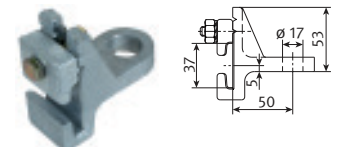

SC 35

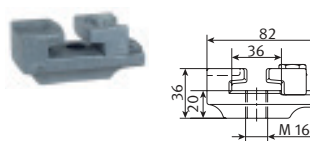

SA 35

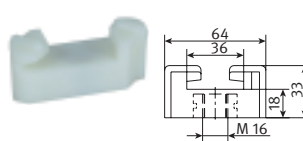

SKD 35

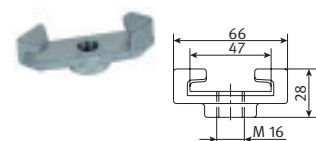

SD 45

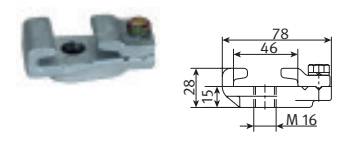

SH 45

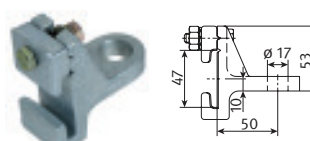

SC 45

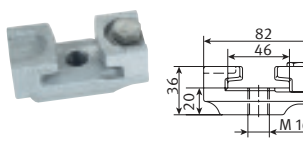

SA 45

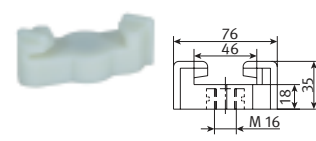

SKD 45

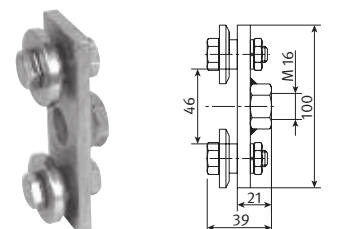

SSR 45

Rail supports

Type	Weight kg	Material	max. ambient temperature °C	for conductors with foot width b mm	Order no. short bolts	Order no. long bolts
STD 20–120	0.26	Grey cast iron	200	20	101 290	–
STD 35	0.47	Grey cast iron	200	35	105 681	101 300
STH 35	0.64	Grey cast iron	200	35	105 682	101 310
STC 35	0.94	Grey cast iron	200	35	105 683	101 320
STA 35	0.54	Aluminum	150	35	–	107 766
STKD 35	0.33	Plastic	80	35	105 687	103 380
STD 45	0.49	Grey cast iron	200	45	105 684	101 330
STH 45	0.64	Grey cast iron	200	45	105 685	101 340
STC 45	0.94	Grey cast iron	200	45	105 686	101 350
STA 45	0.55	Aluminum	150	45	–	106 425
STKD 45	0.35	Plastic	80	45	105 688	103 390

For A-type conductors use conductor holders STA or STKD only.
When installing in slotted holes, use washers in accordance with DIN EN ISO 7093 on both sides.

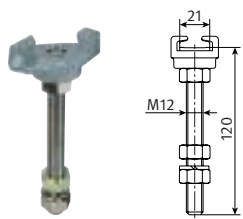

STD 20–120

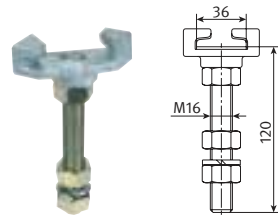

STD 35

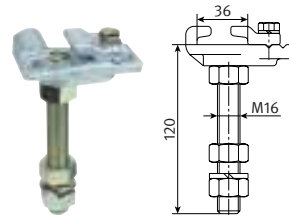

STH 35

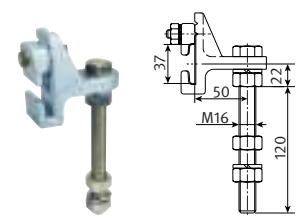

STC 35

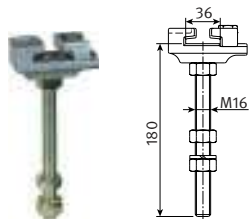

STA 35

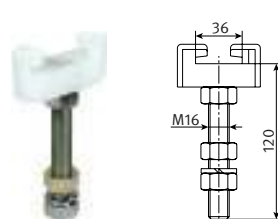

STKD 35

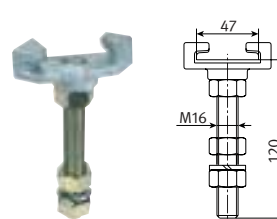

STD 45

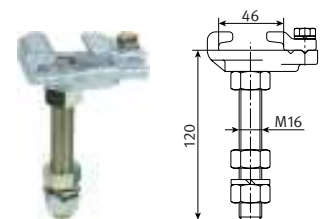

STH 45

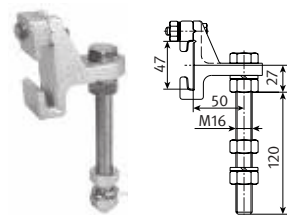

STC 45

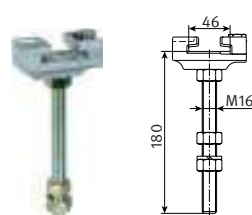

STA 45

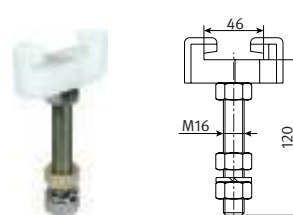

STKD 45

Selection of Current collector

The carbon brushes of the collectors are made with different materials. They must be selected according to the different application conditions.

Chemical influences

Application conditions	Graphite carbon	Met.-Impr. carbon	Metal carbon	Brass ⁽²⁾	Bronze ⁽¹⁾	Cast iron ⁽¹⁾
Dry indoor installations or moisture-protected outdoor installations	•	•	•	•	•	•
Unprotected outdoor installations or covered steel duct systems	–	•	•	•	•	•
Systems with corrosive environment	–	•	•	•	•	–
Systems with intensive corrosive environment	–	–	•	•	•	–
Systems with aggressive environment	–	–	•	–	•	–

Operating conditions

Application conditions	Graphite carbon	Met.-Impr. carbon	Metal carbon	Brass ⁽²⁾	Bronze ⁽¹⁾	Cast iron ⁽¹⁾
High traversing frequency	•	•	–	–	–	•
Low traversing frequency	•	•	•	•	•	•
Standard operation	–	–	•	•	•	–
High degree of soiling, e.g. coking plants	–	•	–	•	–	–

Application temperatures depend on the respective conductor used (see table on page 6)
Traversing speed max. 250 m/min.

• = suitable (1) = Only suitable for steel conductors
– = not suitable (2) = Only for conductor cleaning

Current collector

GSV 1

Contact pressure is suitable for all installation arrangements: 60 N
 Connection option for the cable: M 8
 Lift: ± 55 mm
 Wear height of standard carbon brushes: 11.5 mm
 Type "S": 18.0 mm
 Suitable conductor: 20 mm foot width

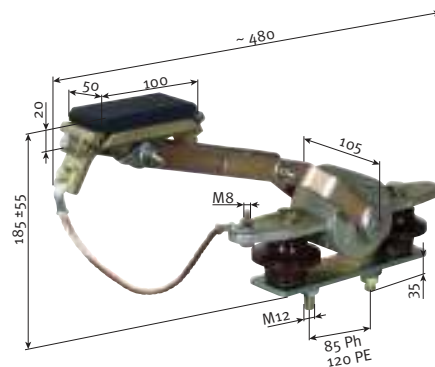

Type	Max. load capacity A	Carbon brush		Weight kg / m	Order no.		
		Material	Dimensions		Phase	Ground conductor	
						insulated	non-insulated
GSV 1	100	Graphite carbon	50 x 100 x 20	5.20	102 080	102 090	103 920
GSV 1 / mi	100	Met.–Impr. carbon	50 x 100 x 20	5.33	102 100	102 110	103 930
GSV 1 / Smi	100	Met.–Impr. carbon	80 x 100 x 30	6.01	102 140	102 150	103 950

GSV 2

Contact pressure is suitable for all installation arrangements: 90 N
 Connection option for the cable: M 12
 Lift: ± 55 mm
 Wear height of the carbon brushes: 18.0 mm
 Installation height GSV 2/N.: 220 ± 70 mm

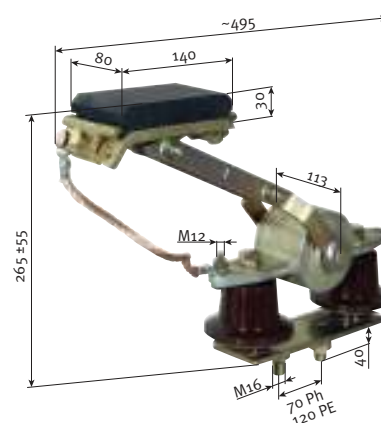

Type	Max. load capacity A	Carbon brush		Weight kg / m	Order no.		
		Material	Dimensions		Phase	Ground conductor	
						insulated	non-insulated
GSV 2	200	Graphite carbon	80 x 140 x 30	9.30	102 200	102 210	103 980
GSV 2 / mi	200	Met.–Impr. carbon	80 x 140 x 30	9.55	102 220	102 230	103 990
GSV 2 / Nmi	200	Met.–Impr. carbon	80 x 140 x 30	8.86	102 240	102 250	104 000
GSV 2 / Smi	200	Met.–Impr. carbon	100 x 140 x 30	10.16	107 200	107 201	107 301
GSV 2 / Bz	200	Bronze	90 x 125 x 15	9.56	107 221	107 222	107 223
GSV 2 / Ms	200	Brass	90 x 125 x 15	9.56	102 260	102 270	104 010
GSV 2 / GG	200	Cast iron	90 x 140 x 15	9.22	102 280	102 290	104 300

(i) Current collectors with increased corrosion protection on request

Current collector

GSV 4

Contact pressure is suitable for all installation arrangements: 120 N
 Connection option for the cable: M 12
 Lift: ± 70 mm
 Wear height of the carbon brushes 18 mm
 Installation height for GSV4/N.: 250 ± 70 mm

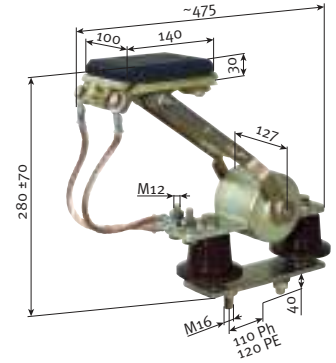

Type	Max. load capacity A	Carbon brush		Weight kg / m	Order no.		
		Material	Dimensions		Phase	Ground conductor	
						insulated	non-insulated
GSV 4	400	Graphite carbon	100 x 140 x 30	11.72	102 300	102 310	104 020
GSV 4 / mi	400	Metal impreg. carbon	100 x 140 x 30	12.10	102 320	102 330	104 030
GSV 4 / Nmi	400	Metal impreg. carbon	100 x 140 x 30	11.58	102 340	102 350	104 070
GSV 4 / Smi	400	Metal impreg. carbon	140 x 140 x 30	13.16	104 040	104 050	104 060
GSV 4 / Bz	400	Bronze	90 x 125 x 15	11.57	106 867	106 868	106 704
GSV 4 / Ms	400	Brass	90 x 125 x 15	11.57	102 360	102 370	104 080
GSV 4 / GG	400	Cast iron	112 x 140 x 14	11.57	105 511	105 512	105 530

GSV 8

Contact pressure is suitable for all installation arrangements: 140 N
 Connection option for the cable: M 12
 Lift: ± 70 mm
 Wear height of the carbon brushes 18 mm
 Installation height for GSV8/N.: 270 ± 70 mm

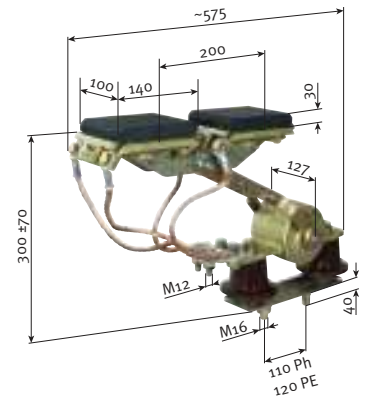

Type	Max. load capacity A	Carbon brush		Weight kg / m	Order no.		
		Material	Dimensions		Phase	Ground conductor	
						insulated	non-insulated
GSV 8	800	Graphite carbon	100 x 140 x 30	15.34	102 380	102 390	104 090
GSV 8 / mi	800	Metal impreg. carbon	100 x 140 x 30	15.79	102 400	102 410	104 100
GSV 8 / Nmi	800	Metal impreg. carbon	100 x 140 x 30	15.43	102 420	102 430	104 140
GSV 8 / Smi	800	Metal impreg. carbon	140 x 140 x 30	18.16	104 110	104 120	104 130
GSV 8 / Bz	800	Bronze	90 x 125 15	11.57	107 192	107 194	107 213
GSV 8 / Ms	800	Brass	90 x 125 x 15	11.57	102 440	102 450	104 150
GSV 8 / GG	800	Cast iron	112 x 140 x 14	11.57	105 522	105 523	105 524

Current collectors with increased corrosion protection on request

Current collector

Type DVD for conductors with 20 mm foot width

Contact pressure: 50 N
 Connection option for the cable: M 8
 Lift: ± 40 mm
 Wear height of the carbon brushes 10 mm

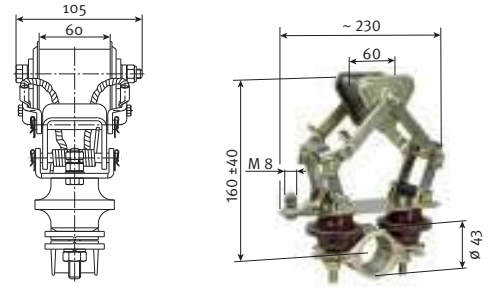

Type	Max. load capacity A	Carbon brush		Weight kg / m	Order no.		
		Material	Dimensions		Phase	Ground conductor	
						insulated	non-insulated
DVD	100	Graphite carbon	60 x 60	2.56	102 480	102 490	104 170
DVD ⁽¹⁾ galvanizing plant	100	Metal graphite	60 x 60	2.56	106 643	106 644	–

Towing arm required DIN EN 10210-2 or DIN EN 10219-2 (Ø 42.5)
 (1) Zinc coating shop version, all steel parts vortex sintered

Type SO for enclosed steel duct systems

Contact pressure: 25 N
 Connecting option for the cable: M 10
 Lift: + 50/- 35 mm
 Wear height of the carbon brushes 15 mm

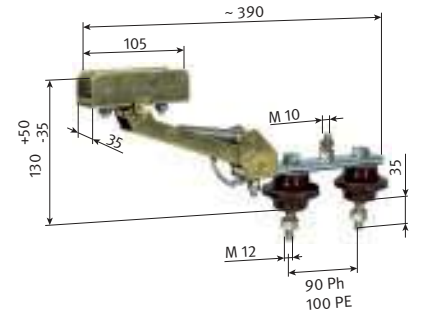

Type	Max. load capacity A	Carbon brush		Weight kg / m	Order no.	
		Material	Dimensions		Phase	Ground conductor
SO	120	Metal graphite	105 x 36 x 25	1.56	102 540	102 550
SO	180	Metal graphite	105 x 36 x 25	1.56	107 117	107 118

Type BVS for enclosed steel duct systems

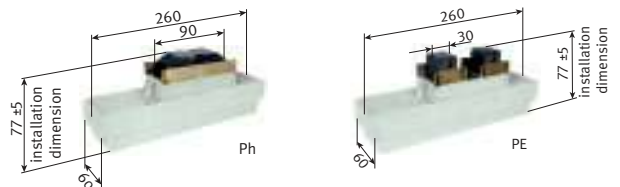

Wear height of the carbon brushes 20 mm

Wear height of the carbon brushes 25 mm

Type	Max. load capacity A	Carbon brush		Weight kg / m	Order no.	
		Material	Dimensions		Phase	Ground conductor
BVS / 1	120	Metal impreg. carbon	90 x 34 x 42	1.40	102 560	–
BVS / 1	120	Metal impreg. carbon	30 x 34 x 43	1.30	–	102 570
BVS / 2	180	Metal graphite	90 x 34 x 42	1.96	105 891	–

Current collector

KSKS - Current collector for offset compensation

Wear height of the carbon brushes 14 mm

Lateral installation is not permitted.

Use of special connecting material is required (on request).

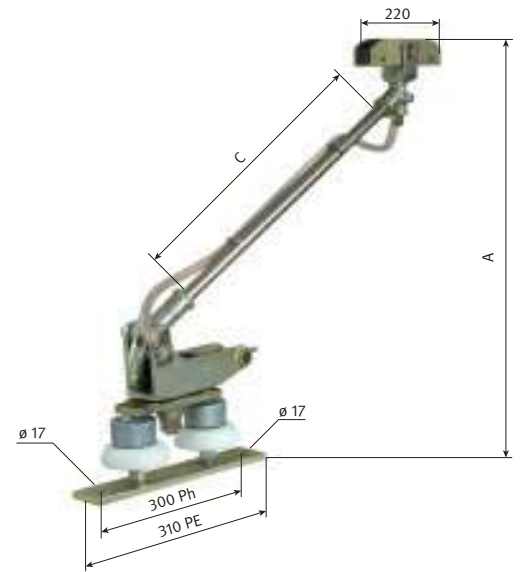

Please specify the "C" dimension when ordering.
The following dimensions are calculated based on the different lengths of brush holder rods:

Dimension C	Dimension A		
	min.	normal	max.
600	340	650	950
800	340	750	1150
1000	340	850	1350

Type	Max. load capacity A	Carbon brush		Weight kg / m	Order no.	
		Material	Dimensions		Phase	Ground conductor
KSks 2 / 600	200	Metal impreg. carbon	30 x 220 x 40	17.01	105 170	105 320
KSks 2 / 800	200	Metal impreg. carbon	30 x 220 x 40	17.55	105 180	105 330
KSks 2 / 1000	200	Metal impreg. carbon	30 x 220 x 40	18.24	105 190	105 340
KSks 4 / 600	400	2 Metal impreg. carbon	2 x 30 x 220 x 40	22.53	102 510	102 530
KSks 4 / 800	400	2 Metal impreg. carbon	2 x 30 x 220 x 40	23.12	105 590	105 594
KSks 4 / 1000	400	2 Metal impreg. carbon	2 x 30 x 220 x 40	23.85	105 591	105 595

Spare parts for Current collector GSV

Position	Article	Order no. GSV 1	Order no. GSV 2	Order no. GSV 4	Order no. GSV 8
1	Spring housing, complete Standard	108 008	108 010	108 012	108 014
2	Lever 1 set, complete Standard	108 295	108 321	108 325	108 325
3	Carbon holder, complete Standard	102 740	102 890	102 990	108 289
	Carbon holder, complete S version	102 790	102 990	108 291	108 287
4	Carbon brush, graphite	102 720	102 870	102 970	102 970
	Carbon brush, graphite S version	102 770	102 970	105 558	105 558
	Carbon brush, metal impreg.	102 730	102 880	102 980	102 980
	Carbon brush, metal impreg. S version	102 780	102 980	104 190	104 190
5	Collector shoe bronze	107 275	106 624	106 624	108 671
	Collector shoe brass	102 750	103 000	108 666	108 668
	Collector shoe cast iron	–	102 910	106 409	108 648
6	1 set Cu braid	102 710	102 860	102 960	103 040
7	Insulator phase	108 356	108 358	108 358	108 358
	Insulator phase for N version	–	108 360	108 360	108 360
	Insulator PE	108 375	108 373	108 373	108 373
	Insulator PE for N version	–	108 381	108 381	108 381
8	Base plate phase (+ N version)	105 575	105 578	105 582	105 582
	Base plate PE insulated (+ N version)	105 576	105 579	105 583	105 583
	Base plate PE non-insulated	105 577	105 580	105 584	105 584
	Base plate PE insulated for N version	–	105 581	105 585	105 585
9	Swing	–	–	–	103 050



1) Spring housing



2) Lever



3) Carbon holder



4) Carbon brush



5) Collector shoe (Bz/Ms)



5) Collector shoe (GG)



6) Cu braid



7) Insulator



8) Base plate



9) Swing

Spare parts vortex sintered on request

Spare parts for Current collector DVD

Position	Article	Order no.
1	Base plate, Standard	103 190
1	Base plate, vortex sintered	106 655
2	Bracket, Standard	103 200
2	Bracket, vortex sintered	106 652
3	Lever, Standard	103 210
3	Lever, vortex sintered	106 654
4	Lever, Standard	105 690
4	Lever, vortex sintered	106 940
5	Clamp, Standard phase	106 019
5	Clamp, vortex sintered	107 954
5	Clamp, Standard PE	106 020
5	Clamp, vortex sintered	107 955
6	Cu braid, 1 set	103 250
7	Leg spring	103 260
7	Leg spring, (Zinc coating shop)	108 855
8	Brass spacer tube	103 270
9	Insulator phase	103 150
9	Insulator PE	105 370
9	Insulator, (Zinc coating shop)	106 645
10	Triangular carbon, metal impreg.	103 280
10	Triangular carbon MK (Zinc coating shop)	106 727
11	Carbon fiber	103 180
12	Carbon fiber (Zinc coating shop)	108 856
13	Bolts	107 231
14	Contact grease (100 ml for approx. 200 connections)	121 502

Pos. 12 ø 50 mm (not illustrated)

Pos. 14 (not illustrated)

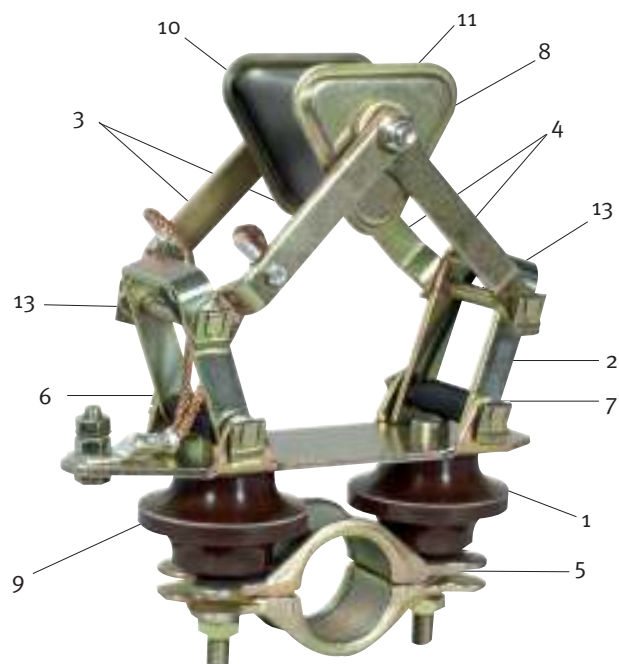

Spare parts for Current collector SO, BVS and KSKS

Position	Article	Max. load capacity A	Order no. Phase	Order no. PE
1	Carbon brush SO	120	103 310	103 320
1	Carbon brush SO	180	105 735	107 101
2	Cu braid	120	107 092	107 093
2	Cu braid	180	107 096	107 103
3	Carbon brush BVS	120	103 330	103 340
3	Carbon brush BVS	180	105 951	–
4	Carbon brush KSKS	–	103 360	103 360

(Other spare parts on request)

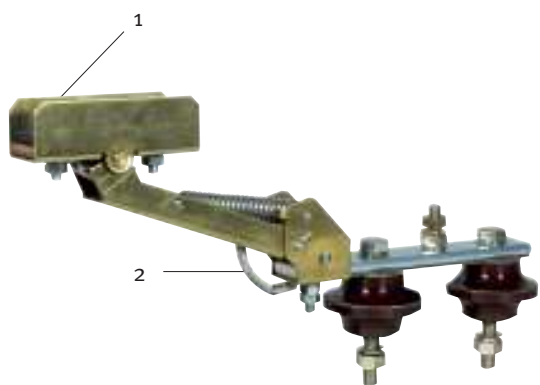

SO

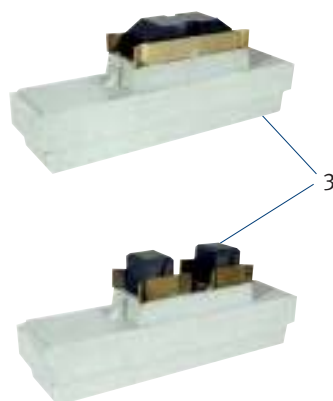

BVS



KSKS

Grounding and short circuiting equipment

4-pole grounding and short circuiting equipment in accordance with DIN EN 61230 (VDE 0683 Part 100)

Using the grounding and short circuiting equipment, the phase conductors are short-circuited or earthed to the ground conductor in event of repairs. The grounding and short circuiting equipment comprises connection terminals including connecting cable.

Type	max. short circuit current I_k 1s in A	Cu cable cross-section	Weight kg	Order no.
Grounding bridge	6900	35 mm ²	5.200	106 889

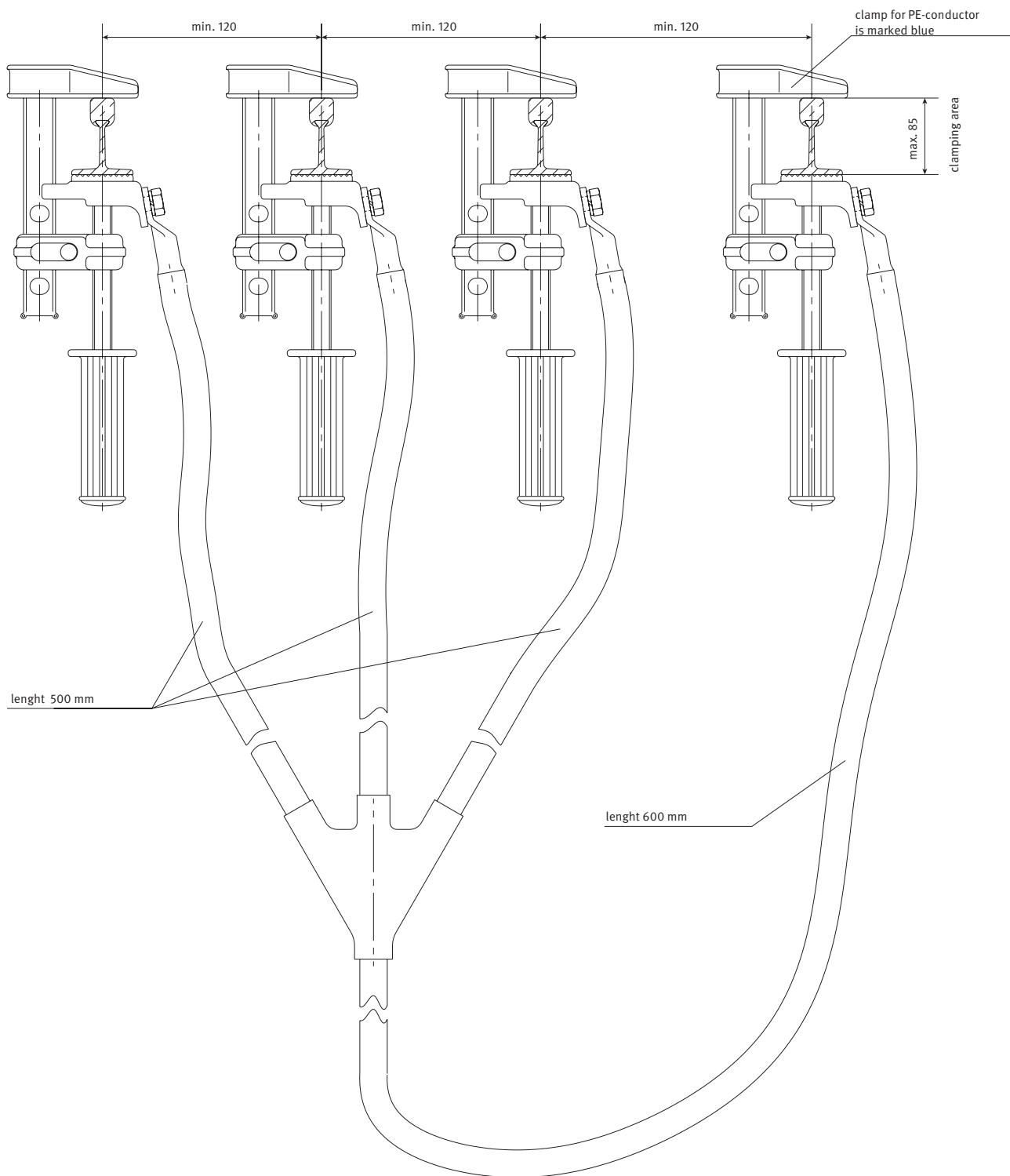

Conductor de-icing

De-icing for steel and aluminium-copperhead conductors and solid copper conductors

De-icing is recommended for outside installations and conductors in wet environments. De-icing is carried out using heating cables that are arranged on the conductor according to the illustration shown below.

The heating cables are routed (pulled) in the copper guard tube when mounting the conductor.

The connecting cables, etc. can be supplied or must be provided and connected by the customer.

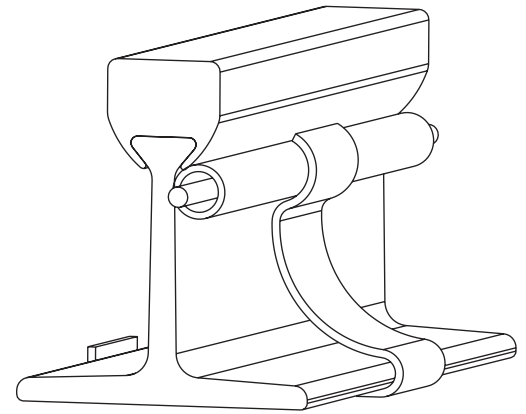

Warning!
Only switch on de-icing below a temperature of +5°C

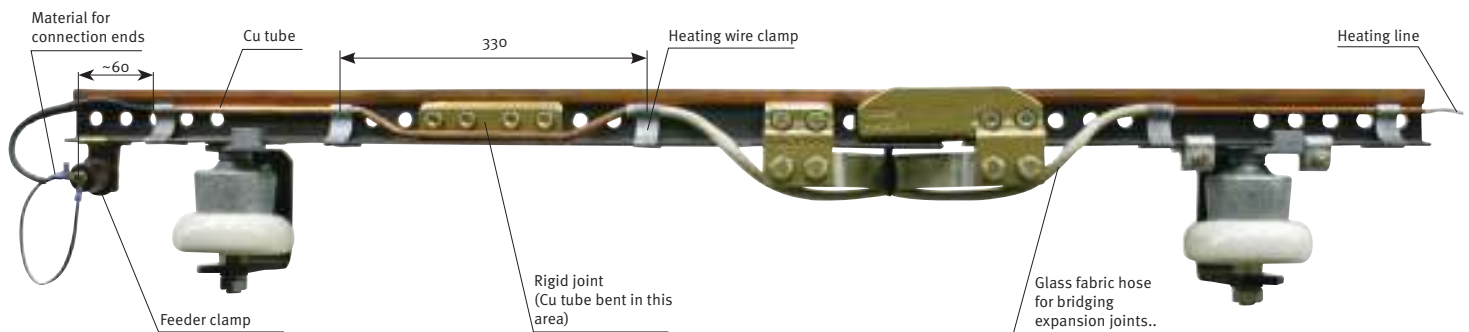

Installation (and retro-fitting) is also possible on conductors which have already been installed, as the copper tube is fixed using galvanized spring clamps. Rigid and expansion joints are bridged according to the illustration.

The heating cable ends are connected to insulated connection terminals.

Cover the joint of the copper tubes using spring clamps.

We supply the following:

- Correct type of heating cable
- Copper protection tube
- Spring clamps
- Glass fabric hose for expansion joints
- Connection terminals
- Material for connection ends (cable shoes etc.)
- Heating line controller

Conductor de-icing is individually engineered for each conductor system. Please send your enquiry.

Conductor de-icing

Selection of heating cable type.

The heating cable has to be selected so that the heating capacity is between 30 and 45 W/m.

With longer heating lengths than are shown in the diagram, the total length must be divided into one or more heating sections.

With smaller heating lengths, current should be fed with respectively lower secondary voltage via a transformer.

With greater voltages, specially insulated heating wires can be used (on request)

$$\text{Heating capacity [Watt/m]: } N' = \frac{U^2}{R \cdot L^2}$$

U = Operating voltage [Volt]

R = Heating cable resistance [Ohm/m]

L = Length of heating section [m]

Resistance value

Design of heating cable:

Resistance wires made from CrNi (multi-wire)
Heating cable insulation made from PTFE (Teflon)

Nickel-plated braided copper

Outer jacket made from PTFE insulation

Outer diameter: 3.7 mm–4.3 mm

Heating cable: H 0.01 → 0.01 Ohm/m

Heating cable: H 0.15 → 0.15 Ohm/m

Heating cable: H 0.20 → 0.20 Ohm/m

Heating cable: H 0.32 → 0.32 Ohm/m

Heating cable: H 0.38 → 0.38 Ohm/m

Heating cable: H 0.48 → 0.48 Ohm/m

Heating cable: H 0.60 → 0.60 Ohm/m

Heating cable: H 0.70 → 0.70 Ohm/m

Heating cable: H 0.81 → 0.81 Ohm/m

Heating cable: H 1.00 → 1.00 Ohm/m

Heating cable: H 1.44 → 1.44 Ohm/m

Heating cable: H 2.00 → 2.00 Ohm/m

Heating cable: H 3.00 → 3.00 Ohm/m

(Deviation ± 2.5%)

Outer diameter: approx. 4 mm

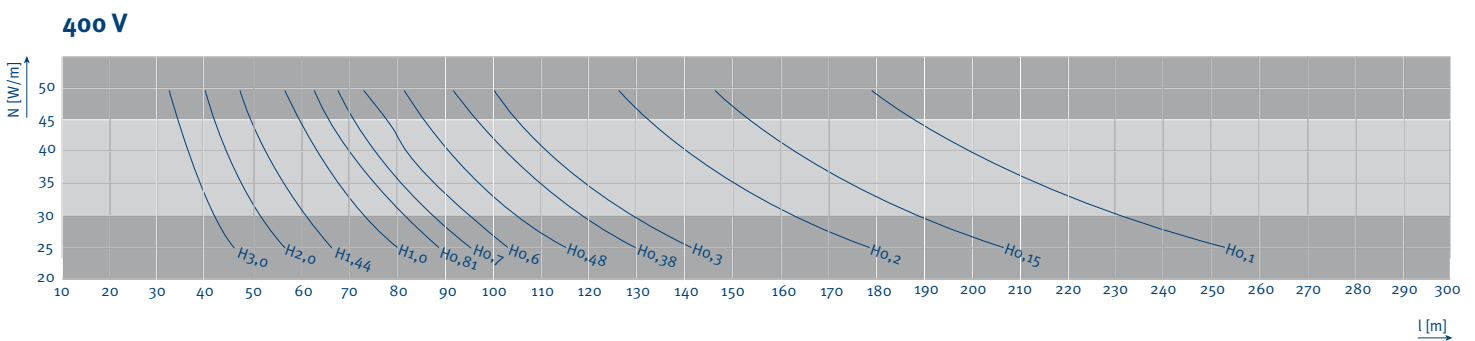
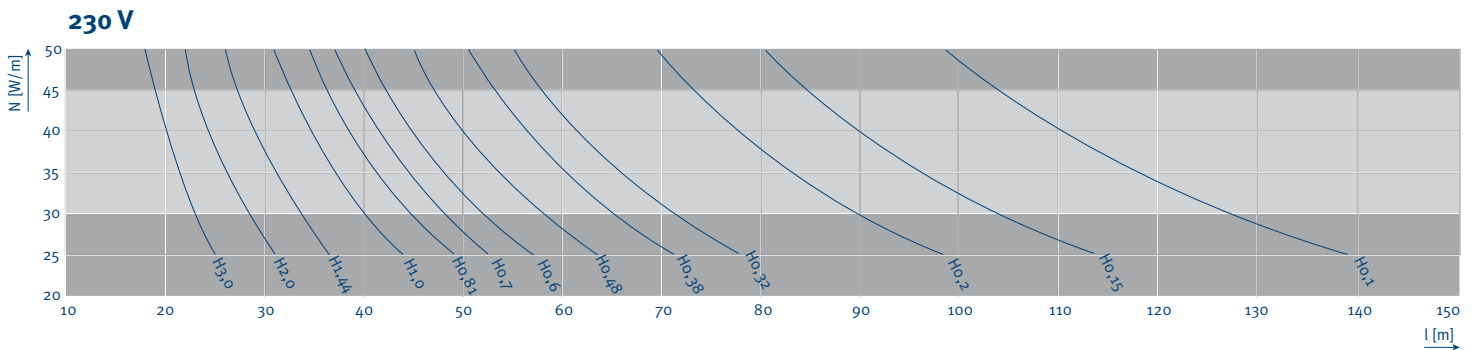

Conductor de-icing

Besides center current feed, end current feed is also possible if the heating capacity is between 30–45 W/m. With other operating voltages as 230V / 400 V mentioned above, de-icing must be calculated for each individual installation.

In order to calculate de-icing, the following information is required:

- System length [L]
- Operating voltage [U]
- Conductor type [F45/...; A35/...]

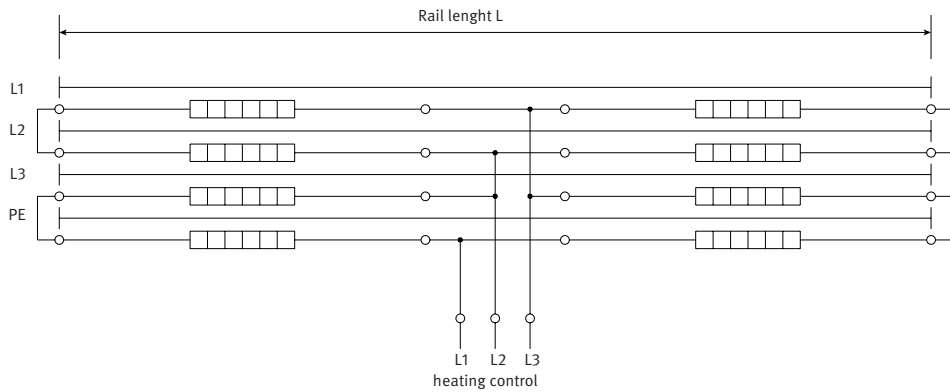

Legend:

- Conductor system
- ▬ heating conductor
- heating conductor feed
- Thermistor bridge

Example: Center current feed (3-conductors + PE)

Example: Conductor de-icing with several heating sections (3-conductors + PE)

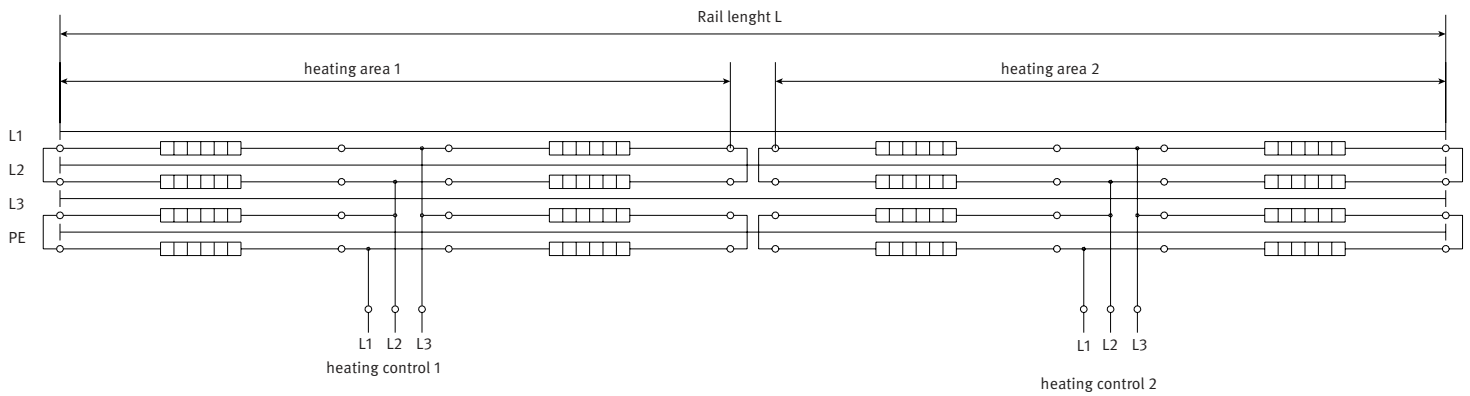

Company: _____ Date: _____
 Tel.: _____ Fax: _____
 e-Mail: _____ Website: _____

1. Number of conductor system installations: _____
2. Type of crane or device which is to be supplied: _____
3. Operating voltage: _____ Volt Phases: Frequency: _____ Hz
 Three-phase current: Alternating current: Direct current:
4. Track length: _____
5. Number of phase conductors: _____ N: _____ Control: _____ Ground: _____
6. Mounting position of conductor system:
 Conductor line and current collector in horizontal position Conductor line laterally mounted / current collector laterally mounted
 Others: _____
7. Number of cranes or pieces of equipment on conductor installation: _____
8. Indoor installation: Outdoor installation:
9. Special operating conditions (humidity, dust, chemicals, etc.)
10. Ambient temperature: _____ °C min. _____ °C max.
11. Building expansion joint: _____ St. min. _____ max. rotation
12. Position and number of feeds⁽¹⁾: _____
13. Position and number of isolated sections (e.g. for repair work)⁽¹⁾: _____
14. How are the conductor systems laid out? _____
15. Travel speed when moving slowly: _____ in curves: _____ at transfers: _____
16. Power consumption of the individual consumer loads: _____
(Use the chart below.)
17. Max. voltage drop of the conductor feed to the current collector when considering the start-up currents:
 3% or _____% related to the nominal current.

Motor specification	Crane / equipment 1						Crane / equipment 2							
	Capacity kW	Nominal current			Start-up current		Drive type ⁽²⁾	Capacity kW	Nominal current			Start-up current		Drive type ⁽²⁾
		A	cos φ _N	% ED	A	cos φ _A			A	cos φ _N	% ED	A	cos φ _A	
Main hoist														
Aux. hoist														
Travel motor														
Trolley motor														

Mark motors which could be in operation simultaneously with *.

Mark motors which could be started simultaneously with Δ.

Additional information: _____

⁽¹⁾ Sketches for processing the offer required
⁽²⁾ Enter drive type: K for squirrel cage, S for slip-ring, F for frequency controlled motor
 We reserve all rights to make alterations in the interests of further development.
 Please copy and fax the questionnaire.

Signature _____

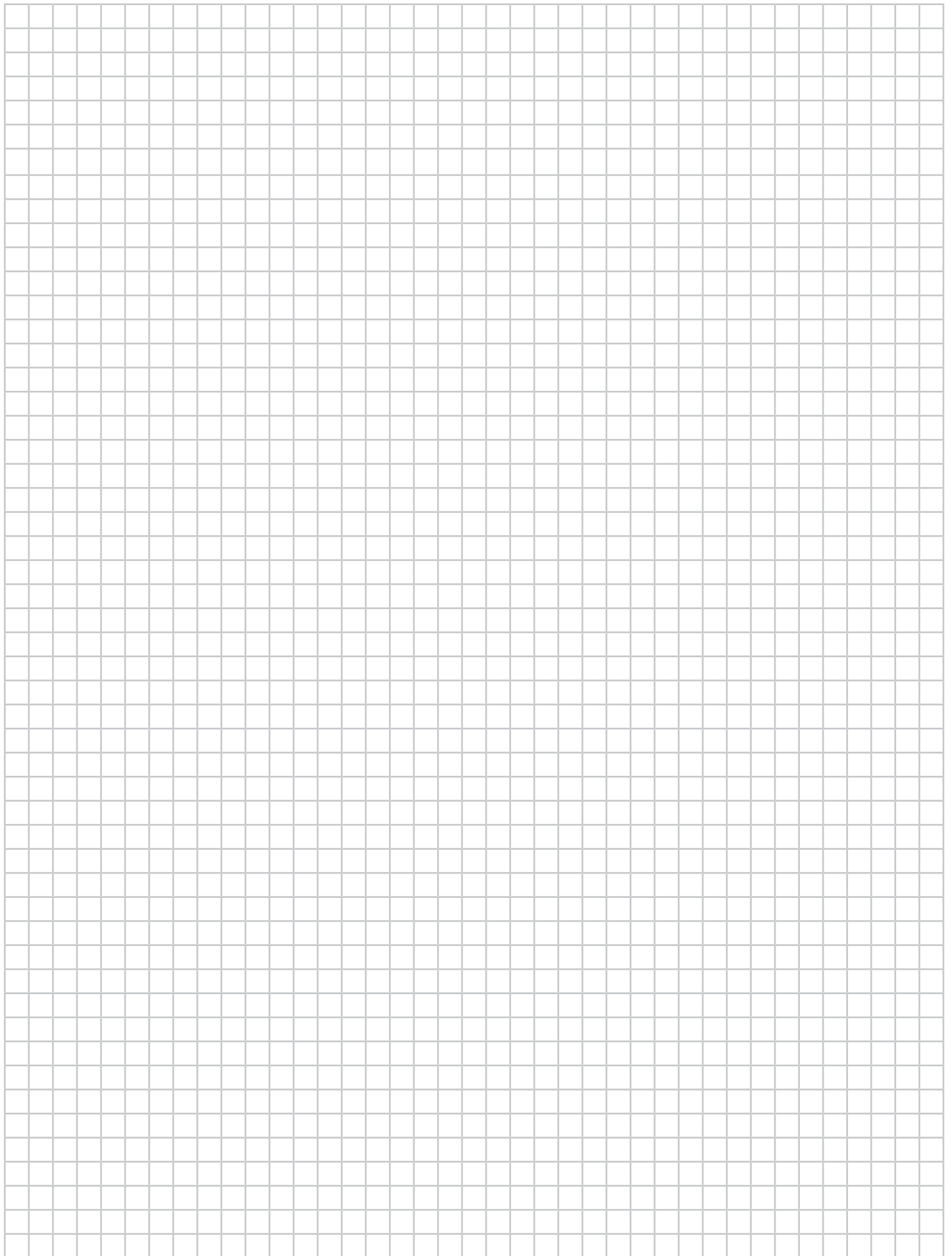







Paul Vahle GmbH & Co. KG

Westicker Str. 52
59174 Kamen
Germany

+49 2307 7040
info@vahle.com
vahle.com

You can find your local contact at:

vahle.com/contact